

2013 EDITION

BAREFOOT WATER-SKI TECHNICAL RULES — 2013



This book belongs to:

Copyright 2013 by International Waterski & Wakeboard Federation (IWWF) - World Barefoot Council. All Rights Reserved.

Reproduction of any part or whole of this document is prohibited unless written permission has been obtained from the IWWF World Barefoot Council.

Revised May 8, 2013

THE GREATEST BAREFOOT AMBASSADOR OF THEM ALL!



BANANA GEORGE BLAIR

George remains the true inspiration for all of us. In his 98th year, he still continues to promote our sport at all levels and to all people.

Twenty-eight years ago, George first sponsored the printing of the International Waterski and Wakeboard Federation's World Barefoot Council Technical Rule Book. George continues to support and inspire the World Barefoot Council to ensure that our skiers and officials have the tools and rules they need to keep the Barefoot playing field level for everyone.

The World of Barefooting salutes you George.

RULE CHANGES FOR 2013 WBC TECHNICAL RULES

Global Changes

Most Chapters have been reorganized and relocated for logical placement, see below.

Some rules have been combined into one section, and some sections have been divided into multiple sections.

Most rules have been relocated because of the reorganizing of the Chapters and many rules in a Chapter have been relocated for logical placement.

PART I—TOURNAMENT REQUIREMENTS

Chapter 1—Abbreviations and Definitions

1. Added definition for Appointed Officials.
2. Revised the definition of BSP to include the new definition Line BSP.
3. Added a definition for SS BSP
4. Added a definition for Line BSP
5. Added a definition for Event Judges
6. Revised Course Speed term so that its clearer.

Chapter 2—General Requirements

1. 200: Added text that these rules also govern both RC and RL tournaments
2. 202: Revise rule exception from Appointed Judges to Appointed Officials
3. 205(B): Added text that these rules supersede Federation rules for RC and RL tournaments.
4. 209: Revised rule to include that a skier can also be DQ'd for unwarranted harassment of officials
5. 210: Permit event results to be official posting via electronic method
6. 212(B) Clarify the Event Judge requirements for RC tournaments.
7. 213(C): Add limitation on the number of rounds permitted for a RL tournament.

Chapter 3—Skier Instructions

1. 302(D)(1): Clarify that skier is permitted to call "max speed" and driver must never attempt to use speed tolerance intentionally.
2. 302(D): Added note that mandatory re-ride is required for over maximum upper tolerance speed in jump event.
3. 303: Better defined the use of preparatory actions or tricks before start of pass in Slalom and Tricks
4. 303(C)(2) Added text to ensure that the driver must never attempt to use speed tolerance intentionally.
5. 303(E): Allowed for other forms of "on speed" signal to skier

Chapter 4—Jump Event

1. 407(C): Speed Adjudicator optional in Jump event if boat has speed-control.
2. 4067D): Clarify the location of the swimmer and backboard in Jump Event

Chapter 5—Slalom Event

1. 507(E): CJ authorization required for in-boat scoring.

Chapter 6—Start Tricks (New Chapter)

1. 601(B): Clarify the one-attempt start rule for credit.
2. 601(E): Better defined the one-foot start and conditions on downgrade.
3. 603: Change "Flyer" starts to "dock, tower, and dry land (flyer)" starts.
4. 604(E)(F)(G)(H): Delete text that prohibited lifted foot to touch water in TT tricks.
5. 604(E)(F)(G)(H): Revised rule to allow skier to reverse direction in TT start tricks.
6. 604(J): Permit back toe-up to be preformed faced up or down for full point credit.

Chapter 7—Trick Pass General

1. Removed trick penalties [1610 rule in 2012]
2. 707(B): Clarify credit rules tricks that required less than 90 degree recovery.

3. 708: Permit failed basic trick to be immediately repeated for credit.
4. 716: New section to contain downgrade rules.

Chapter 8—Pass Trick Descriptions

1. Removed all penalties
2. 801(E) Rope-on-Neck tricks will be permitted.
3. 801(F) Rope-in-Teeth tricks will be permitted.
4. 01(J): Switch-stance trick must originate from SS BSP. When this occurs both SS and switch-stand tricks could be credited.
5. 803(A): Required a change of rotation direction between ALL surface turns.
6. 812: Added a new trick toe-front stand up from the seated position.

Chapter 9—Protests

1. 902(2) Permit protest for safety.
2. 903: Changed the protest procedure to have the Chief Judge adjudicates all protests.
3. 904: Add section on the process to reverse the Chief Judge's decision

Chapter 10—Re-Rides

1. 1004(C): Require the skier to have possession of handle during jump speed check to receive re-ride.
2. ef1008: Permit skier to change start and pass instructions for reride pass.

Chapter 11—Safety

1. 1103(B): New section containing rules governing the condition that the skier loses helmet in the jump event.
2. 1104(A): Changed "safety swimmer" with "safety director" to better describe the application of the rule.
3. 1104(D): Required a life jacket to be in boat at all times.
4. 1104(E): Required a swimmer with floatation and backboard to be located at the jump area.

Chapter 12—Time Rules (new chapter)

1. 1202(B)(2): Clarified when the equipment minute time starts for second pass.

Chapter 13—Video

1. Relocated some requirements to new Chapter 22 World Championships Video

PART II—HOMOLOGATION REQUIREMENTS

Chapter 14—Handles, Ropes, and Timers

1. 1403(B)(1): Identify that the rope with a leader is considered as the "rope" for homologation purposes.
2. 1403(B)(2) Require 2m leader at both the middle and optional attachment points.
3. 1403(B)(3): Increased maximum rope/handle tolerance to match the separate tolerances for both the rope and handle.
4. 1403(D): CJ must approve rope attachment fittings.
5. 1404(B): Additional requirements for skier supplied rope.

Chapter 15—Towboats

1. 1501(E): Require one GPS speed measuring device in the boat.

Chapter 16—Course Requirements

1. 1601(C): Changed minimum run up to jump from 150m to 200m
2. 1602(A)(1): Required dock to be sized at least one step for dock (flyer) start.
3. 1602(A)(2)(b): Required tower to be sized at least one step for tower (flyer) start, and required tower to be contiguous with dock
4. 1602(A)(6): Require shutdown buoy to have contrasting color to skier advisory buoy
5. 1603(B): Changed jump length from approximately 4m to minimum 3.6m
6. 1603(G): Contrasting color required on the top of the ramp to facility surveying

Chapter 17—World Records

1. None

PART III—WORLD CHAMPIONSHIPS, RECORDS, AND RANKING LIST (NEW)

Chapter 18—General Requirements—World Championship

1. 1802: Allowed for alternative arrangements for site homologation

Chapter 19—Divisions and Events—World Championship

1. 1905(B)(1): Allowed the Chief Judge to make schedule changes as necessary
2. 1905(B)(3): Required schedule changes to be announced on PA system.
3. 1906(A)(2): Changed rules on allocated time for independent skiers for site familiarization.
4. 1907: Requires Chief Driver to administer driver familiarization

Chapter 20—Entry Requirements—World Championship

1. 2001(D)(5) Requires injury to replace skier after start of tournament.
2. 2003(B) Allow skiers to participate in jump event for countries with no RL jump competitions.
3. 2005(B)(1): Changed definitive entry requirements
4. 2006(B): Change previous world championship requirements for Junior competitors.

Chapter 21—Event, Overall, and Team Rankings—World Championship

1. None

Chapter 22—Officials—World Championship

1. 2203(D): Recommended that an appointed official be used to monitor water conditions from the pickup boat.
2. 2203(E): Recommended that an appointed official be used to monitor conditions at starting dock.

Chapter 23 –Video and Communications—World Championship (New)

1. Relocated some video rules from new Chapter 14 to this new Chapter.
2. 2201: Require a “minimum” of three video operators, previous rule specified “three only.”

TABLE OF CONTENTS

RULE CHANGES FOR 2013 WBC TECHNICAL RULES	iii
--	-----

PART I—TOURNAMENT REQUIREMENTS

CHAPTER 1: ABBREVIATIONS AND DEFINITIONS	2
101: Abbreviations	2
102: Definitions.....	2
CHAPTER 2: GENERAL REQUIREMENTS	4
201: Introduction	4
202: Convention	4
203: Exceptions to the Rules	4
204: Interpretation of the Rules	4
205: Rules Revision.....	4
206: Amendments to the Rules	4
207: Rule Change Procedure	4
208: New Tricks.....	5
209: Interruptions and Stoppage	5
210: Disqualification.....	5
211: Results Posting	5
212: Replacing Officials.....	5
213: Event Judges	6
214: WBC Ranking List.....	6
CHAPTER 3: SKIER INSTRUCTIONS	7
301: Commands	7
302: Jump Event.....	7
303: Slalom and Trick Event.....	7
CHAPTER 4: JUMP EVENT	9
401: Start	9
402: Start of Pass—Jump Attempt.....	9
403: Passes—Jumps	9
404: Credit for Jump	9
405: Disallowed Jump	9

406: Scoring	9
407: Jump Measurement and Calculation	10
408: Distance	10
409: Officials	10
CHAPTER 5: SLALOM EVENT	11
501: Passes	11
502: Start of Recording.....	11
503: End of Pass	12
504: Credit.....	12
505: Scoring	13
506: Officials	14
CHAPTER 6: START TRICKS	15
601: General	15
602: Scoring	15
603: Dock, Tower, or Dry-Land Start (Flyer)	15
604: Start Trick Descriptions	16
CHAPTER 7: PASS TRICKS—GENERAL REQUIREMENTS	18
701: Passes	18
702: Start of Time and Recording	18
703: End of Scoring	18
704: Credit for Tricks	18
705: Skier Responsibility	18
706: Loss of BSP.....	18
707: Repeating Failed Tricks	19
708: Trick After Expiration of Time	19
709: Reverse Tricks	19
710: Simultaneous Tricks.....	19
711: Precursory Tricks	19
712: Scoring—Trick Point Values	19
713: Bonus Actions.....	20
714: Officials	20
715: Downgrades	21
716: One Attempt for Credit.....	21

CHAPTER 8: PASS TRICK DESCRIPTION	22	CHAPTER 12: TIMING RULES	36
801: General Pass Tricks.....	22	1201: Turn-Around Times.....	36
802: Turn Tricks General.....	24	1202: Equipment Failure, One-Minute.....	36
803: Rotation Rule for Surface-Turns	24	1203: Emergency, One-Minute	36
804: 180 Back-to-Front.....	25	1204: Injury Recovery, Three-Minutes	36
805: 180 Front-to-Back.....	25	1205: Re-Ride, Five-Minute Rest	36
806: 360 Front-to-Front	25	1206: Temporary Incapacitation Recovery Time	36
807: 360 Back-to-Back.....	26	CHAPTER 13: VIDEO AND RADIOS	37
808: 540 Turns.....	26	1301: Assignment.....	37
809: 720 Turns.....	26	1302: Media.....	37
810: Step-Over Turn	26	1303: Official Use	37
811: Rope-on-Foot Turn Feet-to-Feet.....	27	1304: Communications	37
812: Rope-on-Foot Turn Toe-Start Recovery	27	PART I GRAPHICS	38
813: Somersault.....	28	PART I TECHNICAL REQUIREMENTS	
CHAPTER 9: PROTESTS	29	INDEX	46
901: Protest Basis	29		
902: Protest Procedure	29		
903: Chief Judge Decision	29		
904: Reverse Chief Judge Decision	29		
905: Calculation Error	29		
CHAPTER 10: RE-RIDES	31		
1001: Re-Ride Request.....	31		
1002: Scoring of Re-Ride.....	31		
1003: Optional Re-Ride.....	31		
1004: Mandatory Re-Ride	31		
1005: Re-Rides—When Taken	32		
1006: Re-Ride Options—Trick	32		
1007: Not Basis for a Re-Ride	32		
1008: Start and Pass Instructions	33		
1009: Refusal to Enter Course	33		
1010: Provisional Score	33		
CHAPTER 11: SAFETY	34		
1101: Safety Director.....	34		
1102: Flotation and Protection	34		
1103: Helmets.....	34		
1104: Safety Officer.....	34		
1105: Disqualification.....	35		
		PART II—HOMOLOGATION	
		REQUIREMENTS	
		CHAPTER 14: HANDLES, ROPES, AND	
		TIMERS	49
		1401: General	49
		1402: Handles.....	49
		1403: Ropes	49
		1404: Skier Supplied Rope and Handle	50
		1405: Audible Timing Device.....	50
		CHAPTER 15: TOWBOATS	51
		1501: Boat Specifications.....	51
		1502: Top Speed Advisory.....	51
		1503: Speed Check	51
		1504: Speed Control.....	51
		CHAPTER 16: COURSE REQUIREMENTS	52
		1601: Jump Course	52
		1602: Slalom and Trick Course	52
		1603: Jump Ramp	53
		CHAPTER 17: WORLD RECORDS	54
		1701: Recognition.....	54
		1702: Tournament.....	54
		1703: Jump.....	54

1704: Slalom and Tricks 54
 1705: Equal Performance 54
 1706: Affidavit—Claim Documentation 54
 1707: Verification 55
 1708: Record Appeals 55
 1709: Ratification 55
 1710: Records Set at World Championship 55

PART II GRAPHICS 57

PART II TECHNICAL REQUIREMENTS INDEX 60

PART III—WORLD CHAMPIONSHIPS REQUIREMENTS

CHAPTER 18: GENERAL REQUIREMENTS—WORLD CHAMPIONSHIP 62

1801: Scheduling 62
 1802: Site Closure and Set Up 62
 1803: On-Site Medical Facilities 62
 1804: Towboats 62
 1805: Ropes and Handles 62
 1806: Safety Director 62
 1807: Driver Familiarization 62
 1808: Completion 63
 1809: Validity 63

CHAPTER 19: DIVISIONS, EVENTS, AND ROUNDS OF COMPETITION—WORLD CHAMPIONSHIP 64

1901: Divisions of Competition 64
 1902: Events 64
 1903: Champion and Event Placements 64
 1904: Event Rounds 64
 1905: Schedule of Events 64
 1906: Site Familiarization 65
 1907: The Draw 65
 1908: Starting Order 65
 1909: Semifinals 65
 1910: Finals 66

CHAPTER 20: ENTRY REQUIREMENTS—WORLD CHAMPIONSHIP 67

2001: Nationality 67
 2002: Team Composition 67
 2003: Independent Entrants 67
 2004: Jump Proficiency 68
 2005: Entry Registration 69

CHAPTER 21: OVERALL AND TEAM RANKING—WORLD CHAMPIONSHIP 70

2101: Event Placing 70
 2102: Champions 70
 2103: Ties 70
 2104: Overall Scoring—Application 71
 2105: Overall Scoring—Calculation 71
 2106: Qualification for Overalls 71
 2107: Overall Placing 71
 2108: Team Placing 71
 2109: Score Sheets Access 72

CHAPTER 22: OFFICIALS—WORLD CHAMPIONSHIP 73

2201: Chief Officials 73
 2202: Appointed Judges, Scorers and Drivers 73
 2203: Secondary Positions 73
 2204: Independence 74
 2205: Replacing Officials 74
 2206: Affidavit 74

CHAPTER 23: VIDEO—WORLD CHAMPIONSHIP 75

2301: Appointments 75
 2302: Availability 75
 2303: Boat Loading 75

PART III TECHNICAL REQUIREMENTS INDEX 76

Part I:

TOURNAMENT REQUIREMENTS

CHAPTER 1: Abbreviations and Definitions	2
CHAPTER 2: General Requirements	4
CHAPTER 3: Skier Instructions	7
CHAPTER 4: Jump Event	9
CHAPTER 5: Slalom Event	11
CHAPTER 6: Start Tricks	15
CHAPTER 7: Pass Tricks—General Requirements	18
CHAPTER 8: Pass Trick Description	22
CHAPTER 9: Protests	29
CHAPTER 10: Re-Rides	31
CHAPTER 11: Safety	34
CHAPTER 12: Timing Rules	36
CHAPTER 13: Video and Radios	37

CHAPTER 1: ABBREVIATIONS AND DEFINITIONS

101: ABBREVIATIONS

BSP: Barefoot Skiing Position

LOC: Local Organizing Committee

RC: Record Capable.

RL: Ranking List.

RRC: Records Review Committee.

WBC: World Barefoot Council,
www.WorldBarefootCouncil.com

WSP: World Scoring Program.

102: DEFINITIONS

Appointed Officials: Chief Judge, Chief Scorer, Chief Driver, Chief Video Operator, Homologator, Assistant Chief Judge, Event Judges, Scorers, Drivers, Safety Director, and Tournament Director.

Barefoot Skiing Position (BSP). Barefoot Skiing Position shall be instantly recognized upon the skier satisfying all of the following conditions:

- (1) **Handle.** The skier has possession of the handle.
- (2) **Stable Position.** The skier is riding on the water on one or two bare feet in a stable position and the handle is held in a position that allows the skier's position to be held at will.
- (3) **Supported by Foot/Feet.** The weight of the skier is entirely supported by the foot or feet on the water.

Event Judges. Judges assigned to adjudicate the event as per rule 213.

Fall. Any time after the skier signifies his readiness to commence and any one of the following occurs:

- (1) The skier loses possession of the handle.
- (2) The weight of the skier is not primarily supported by his foot/feet (except where a skier is supported by other parts of the body as

prescribed in the official description of a specific trick or after negotiating the jump) and the skier is unable to regain BSP before the end of the pass.

Force Majeure. Circumstances beyond the control of all parties, e.g. acts of God such as severe weather.

Lift-Off Point. See Wake Crest definition.

Line BSP. The skier is backward with the handle held only between the legs.

One-foot BSP. For the Trick Event, the entire lifted foot shall be at least halfway between the skier's other knee and the water surface.

PPG. Procedures, Policies and Guidelines is the document that contains additional information regarding technical rule interpretations/clarifications, skier rankings, codes of conduct and instructions for completing the Homologation dossier, as may be referenced in the Technical Rules.

Rope-on-Foot BSP. The skier shall have both hands free from the handle and the surface of the water and only the lifted foot holds the handle. The rope shall be in line with the center of the skier's body.

Slide-Slide BSP. Both feet are held in a position at least 90 degrees to the path of the towboat.

Speed. The Driver must attempt to drive to the exact requested speed and never intentionally use the speed tolerance.

- (1) **Course Speed.** The Skiers requested speed through the course, +/- the tolerance for the event.
- (2) **Start Speed.** The Skiers requested speed for the start portion of the pass, +/- the tolerance for the event.
- (3) **Planing Speed/RPM.** The Skier's requested speed/RPM for planing during the second phase of acceleration up to start or course speed, +/- the tolerance for this phase.

Wake. The area of water disturbed by the passage of the towboat lying at rope's length between and including the wake crests (lift-off points).

Wake Crest (lift-off point). The wake crest (lift-off point) is the nominal boundary of the wake and shall be the lift-off points for both Slalom and Tricks. For towboats that create extra waves within the wake, the crest of the outermost waves shall be considered the wake crest (lift-off point).

- (1) **Smooth Shoulder.** If the wake wave has a smooth rounded shoulder, the wave crest (lift-off point) is the point where the wave shoulder begins the downturn to the outside of the wake.

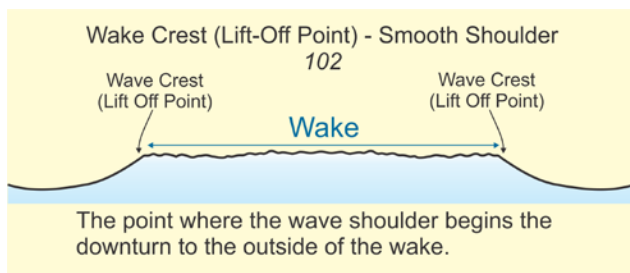

- (2) **Curled Shoulder.** If the wake wave has a curled shoulder, the wave curl is the point of the wave crest (lift-off point).

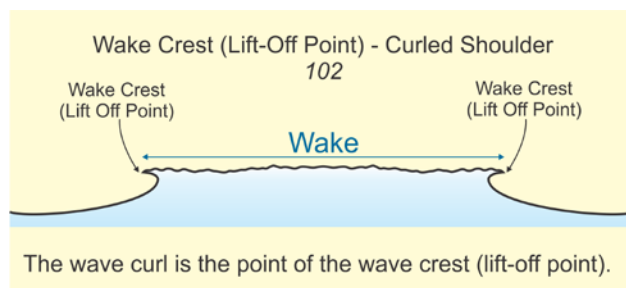

CHAPTER 2: GENERAL REQUIREMENTS

201: INTRODUCTION

These rules become effective on the 1st of January, 2013 and shall govern all World Barefoot Waterski Championships, WBC Record Capability tournaments, and WBC Ranking List Tournaments thereafter until superseded.

These rules have been drafted in English. In case of conflicting interpretation, only the English text shall be considered authentic.

202: CONVENTION

Where the words “he,” “him,” “his,” “himself” are used, they shall be held to apply with equal validity to persons of either sex. This convention is not to be construed in any way as a slight on the fair sex, but adopted purely to avoid impairment of the readability of complex text.

203: EXCEPTIONS TO THE RULES

Where compliance with the rules is not feasible, the Chief Judge shall, with the approval of a majority of the Appointed **Officials**, make the necessary change, inform each skier by posting, and send a report to the WBC. Where the rules are definite and feasible, a vote of the Appointed **Officials** to decide whether to enforce any provision is prohibited.

204: INTERPRETATION OF THE RULES

(A) WBC Interpretations. Questions of interpretation of the rules shall be referred to the WBC when possible. All interpretations approved by the WBC shall be published in the Procedures, Policies and Guidelines (PPG) and are final.

(B) Chief Judge. If an interpretation from the WBC is not possible and an interpretation is not contained in the PPG, an interpretation shall be made by the Chief Judge, and the Chief Judge shall make a report to the WBC concerning the question.

205: RULES REVISION

It is the policy of the WBC to review the rules annually and publish the revised rules (if any) on 1 January of each calendar year. The WBC shall also review the rules at all meetings of the Council. The new rules shall become effective when the WBC publishes them on the WBC approved Internet site at www.WorldBarefootCouncil.com.

206: AMENDMENTS TO THE RULES

(A) Extraordinary Circumstances. In extraordinary circumstances, the WBC is permitted to amend the rule book at any time. Rule amendments made prior to the next January 1st publication of the rule book shall be approved by a minimum of seven voting members of the WBC are effective once published on the official WBC Internet site at www.WorldBarefootCouncil.com.

Note: See 208 for the requirements on introducing new tricks

(B) Federation Technical Rules. For WBC RC or RL tournaments, no federation may adopt technical rules that conflict with these WBC technical rules. Wherever such conflicts exist, those conflicting federation technical rule(s) shall not apply or the scores shall not be valid for submission to WBC.

207: RULE CHANGE PROCEDURE

(A) How to Submit. Any person can submit a proposal to add, edit or delete a requirement of the Technical Rules, via the WBC Rules Committee Chairman.

(B) Proposal Content. The proposal shall contain the following:

- (1) Identify the Rule number to be revised where applicable.
- (2) The text requested to be added, deleted, or revised.
- (3) The reason for the rule change.

Note: Contact information for the WBC Rules Committee is available at www.WorldBarefootCouncil.com.

- (C) **Approval.** The proposed change will be reviewed by the WBC Rules Committee and any proposed change approved by the WBC Rules Committee shall be sent to the WBC for consideration.

208: NEW TRICKS

To qualify new tricks for inclusion in the next World Championships, applications for those new tricks shall be submitted to any member of the WBC no less than 120 days before the next World Championships and the WBC shall then adjudicate on them no less than 60 days before the next World Championships. This application shall be in the form of a video recording of the perfect trick on the long line accompanied by a written description of the trick, and proposed point value for consideration by the WBC.

209: INTERRUPTIONS AND STOPPAGE

- (A) **Interruptions.** In the case of an interruption of the tournament, the tournament shall be restarted as soon as possible without delay.
- (B) **Stoppage.** In the case of a stoppage, the tournament restart shall be announced 10 minutes ahead of time.

210: DISQUALIFICATION

- (A) **Safety Compliance.** Failure of a skier to wear a wet suit or helmet when required shall be cause of immediate disqualification from the event by the Safety Director.
- (B) **Danger to Himself.** No skier shall be allowed to compete or continue to compete if, in the opinion of the Chief Judge, Safety Director and a majority of the Event Judges, his competing would be a danger to himself or to other skiers in the tournament. Whenever practical the advice of a doctor shall be obtained.

- (C) **Unsportsmanlike Conduct.** A skier shall be disqualified by a majority vote of the Appointed Officials due to actions of the skier, parent, spouse or representative who may be charged with unsportsmanlike conduct because of extended or unwarranted harassment of an official or other competitor on behalf of the skier.
- (D) **Detrimental to the Sport.** A skier may be disqualified by a majority vote of the Appointed Officials due to actions considered detrimental to the Organizers or actions considered detrimental to the sport of barefoot water skiing.
- (E) **Not Ready at Starting Dock.** Once the starting order is posted, it's the responsibility of the skier to be present at the starting dock in time for his turn. Any skier who fails to be on immediate hand and in condition to ski when the towboat is ready for him shall be disqualified from the event.
- (F) **Does Not Respond after 10-Second Call.** The skier shall indicate his readiness to go after the 10-second call by the Event Judges. Where a skier fails to indicate his readiness to go by the expiry of the 10 seconds, the Communicator Judge shall call "TIME" and raise his hand to indicate the expiration of time. Should the skier not immediately signal the towboat to go via the "OK" command, the Communicator Judge shall advise the skier that he has been disqualified for that pass.

211: RESULTS POSTING

- (A) **As Soon As Possible.** Event results, electronic, paper or both shall be officially posted as soon as reasonably possible after the conclusion of the event. If the results are not available 30 minutes after the last skier of the day, the official posting will be delayed (except after the last final) until 30 minutes after the start of the next day's competition proceedings.
- (B) **Time of Posting.** The Chief Judge shall record the official time of posting on the event result sheet (electronic or paper copy).

212: REPLACING OFFICIALS

The Chief Judge is permitted to replace Event Judges and Drivers during an event at his discretion. Such changeovers shall take place between groups.

213: EVENT JUDGES

(A) Jump Event

- (1) **WBC Ranking List (RL) Tournament.** The minimum qualifications shall be:
 - (a) Boat Judge— Level 3
 - (b) Video Judge 1— Level 3
 - (c) Video Judge 2— Level 4
- (2) **WBC Record Capability (RC) Tournament.** The minimum qualifications shall be:
 - (a) Boat Judge— Level 3
 - (b) Video Judge 1— Level 2
 - (c) Video Judge 2— Level 3
- (3) **World Barefoot Championships.** The minimum qualifications shall be:
 - (a) Boat Judge— Level 1
 - (b) Video Judge 1— Level 1
 - (c) Video Judge 2— Level 1

(B) Slalom and Trick Event.

- (1) **WBC Ranking List (RL) Tournament.** The minimum qualifications of the event judges shall be two Level 3 Judges and one Level 4 Judge. Combinations of other level judges are allowed, however there shall never be more than one level 4 Judge in the towboat. For single Judge events, a single Level 1 or Level 2 Judge shall be in the towboat.
- (2) **WBC Record Capability (RC) Tournament.** The minimum qualifications of the Event Judges shall be one Level 2 Judge, one Level 3 Judge, and one Level 4 Judge. Combinations of other level judges are allowed; however there shall never be less than one Level 2 Judge and never more than one Level 4 Judge in the towboat. For single Judge events, a single Level 1 or Level 2 Judge shall be in the towboat.

- (3) **World Barefoot Championships.** There shall be three Level 1 Judges in the towboat. A single Level 1 Judge is permitted to replace the three Judges in the towboat in order to obtain and maintain a minimum of 72 kph/44.7mph through the course as required in 1501(A).

Note: See PPG for Levels of officials, experience, and qualifications requirements.

214: WBC RANKING LIST

- (A) **Published List.** The WBC shall publish ranking list scores for jump distance, slalom crossings, and tricks points for all divisions as set forth in the PPG. The Confederations are permitted to recognize ranking lists for divisions other than those recognized by the WBC but those rankings shall have no influence on the WBC published ranking list.
- (B) **Where Set.** Ranking scores shall be set only at tournaments homologated by the WBC, a Confederation, or an Affiliated Federation.
- (C) **Rounds.**
 - (1) No more than four rounds per day are permitted in any one competition.
 - (2) Ranking list rounds shall be declared before the start of the competition.

CHAPTER 3: SKIER INSTRUCTIONS

301: COMMANDS

(A) Terminology. When preparing to start from rest, the skier shall communicate with the towboat only with the words “IN GEAR,” “OK,” or “STOP.” The towboat shall only proceed on the “OK” command.

Note: No re-rides will be given due to departure from the standard terminology as outlined in [1007(B)].

For safety purposes and to ensure proper communication with the towboat, the “STOP” command can be communicated to the towboat crew by raising one hand, thus visually as well as verbally communicating the command to the towboat crew.

(B) Start of Pass. A skier is considered to have started the pass once he gives the “OK” command to the towboat crew.

302: JUMP EVENT

The skier’s instructions to the Event Judges prior to starting a pass shall consist of:

(A) Point of Attachment. The skier shall notify the Event Judges as to the height of rope attachment: “low,” “middle,” or “high.” It is the skier’s responsibility to ensure that the rope is attached at the proper height.

(B) Rates of Acceleration. The requested rates of acceleration in the terms “slow,” “medium,” or “fast” for the three phases: pull out of the water, ride over the bumps, and acceleration to speed.

(C) Path. The towboat shall follow a straight path, parallel to and on the left side of the ramp surface in accordance with the skier’s instructions as follows:

- (1) **Wide.** The towboat shall pass as close to the outside buoys as feasible, but shall not go over the buoy.
- (2) **Split.** The towboat shall pass halfway between the two buoys.

(3) **Close.** The towboat shall pass as close to the inside buoys as feasible but shall not go over the buoy.

The towboat path shall be identical from the start-of-course buoy, ramp gates, and end of course.

(D) Jump Speed.

(1) **Course Speed.** The speed through the jump course shall be requested by the skier in units of 1 kph/1/2 mph or the maximum speed of 72 kph/44.7 mph.

(2) **Speed Obtained.** That course speed shall be obtained not later than when the towboat reaches the jump course entry gates.

(3) **Speed Notification.** On achieving course speed, the driver shall notify the towboat Judge(s) by calling “speed.”

(4) **Speed Tolerance.**

- (a) **Jump Speed Tolerance.** +/- 1.5kph /1mph

303: SLALOM AND TRICK EVENT

The skier’s instructions to the Event Judges prior to starting a pass shall consist of:

(A) Point of Attachment. The skier shall notify the Event Judges as to the height of rope attachment: “low,” “middle,” or “high”; it is the skier’s responsibility to ensure that the rope is attached at the proper height.

(B) Start Trick. The start trick listed in 604 that the skier proposes to perform.

(C) Rates of acceleration. The requested rates of acceleration in the terms “slow,” “medium” or “fast,” for the three phases: pull out of the water or off the dock, tower, or dry land; ride over the bumps; and acceleration to speed.

- (1) At the skier's discretion, the second phase is permitted to be enlarged with other instructions such as, but not limited to; a planing speed/rpm, out of the wash, foot plant, or spin around.

(D) Planing Speed.

- (1) The planing speed/rpm shall be given by the skier in units of 1 kph/1/2mph/100 rpm.
- (2) Once the planing rpm or speed is achieved it shall be held according to the skier's instructions.
- (3) Immediately following the planing portion of the start, the speed shall be adjusted to the start or course speed.

(E) Requested Speeds.

- (1) The skier is permitted to request differing start and course speeds. The start and course speeds shall be given in units of 1 kph/1/2mph, limited by the maximum speed attainable by the towboat.

Note: Failure to achieve a speed greater than 72 kpm/44.7 mph is not grounds for a re-ride [1007(E)].

- (a) **Start Speed.** Once the skier's requested start speed is achieved, it shall be held constant until the skier has obtained BSP.
 - (b) **Course Speed.** Once the skier's requested course speed is achieved it shall be held constant while the skier is in possession of the handle or until the shutdown buoy is reached.
- (2) **Speed Notification.** On achieving planing, start and course speed, the driver shall notify the towboat Judge(s) by calling "speed."

(3) **Speed Tolerance.**

- (a) **Trick and Slalom Tolerance.**
+/-1kph/1/2mph
- (b) **Planing Speed/RPM Tolerance.**
+/-5kph/3mph/200 rpm.

(F) Preparatory Tricks. For the trick event only, preparatory tricks shall be declared. These include but are not limited to: a turn to reverse direction after the start; toeholds in preparation for a toehold turn; lifting a foot to test whether the towboat is up-to-speed or to prepare for a one-foot turn. There is no limit to the number of preparatory tricks the skier may declare. See 702

(G) Path. During the pass the towboat shall follow a straight path, approximately down the center of the course while the skier is in possession of the handle or until the shutdown buoy is reached

(H) Speed Signal for Skier. The skier may request a signal when the planing, start, and/or course speed is attained.

- (1) **Signal.** This signal can take the form of sound, a hand signal, a tap/chop on the rope, or other available form of signal recognized by the skier as permitted by the Chief Judge.
- (2) **When Signal Not Required.** The requested signal is not required if the skier attempts the start or commences the pass before the start and/or course speed is reached.

(I) Engine Trim Position. The skier can request the driver to change the engine trim position from the default position and is responsible to approve its placement before commencing.

Note: No re-ride shall be given due to incorrect engine position after the skier has adjusted the trim from the default position [1007(L)].

CHAPTER 4: JUMP EVENT

401: START

The skier shall start by means of a deepwater start and shall pass the start-of-course buoy in forward BSP and maintain it to the ramp, both to be judged from the towboat.

402: START OF PASS—JUMP ATTEMPT

A skier is considered to have started the pass once he gives the “OK” command to the Boat Judges in accordance with 301.

403: PASSES—JUMPS

- (A) **Number of Jumps.** In each round each skier shall be allowed three registered jumps.
- (B) **Exceptional Circumstances.** In exceptional circumstances the Chief Judge and the Appointed Officials are authorized to vote to reduce the number of jumps for a round to a minimum of two, and post a notification before the start of the round affected.
- (C) **Skier Loses Helmet.** If a skier loses his helmet during the start or before reaching the jump ramp, the towboat shall immediately stop unless it's unsafe to do so. Should it be unsafe for the towboat to stop, the skier shall ski past the jump whenever possible, and this jump shall be scored as a fall. These are not grounds for disqualification from the remainder of the event.

404: CREDIT FOR JUMP

- (A) **Jump Scored.** All jumps not disallowed under rule 405 shall be registered.
- (B) **BSP after Jump.** After landing a jump, the skier can release the handle at any time after attaining BSP.
- (C) **End of Course.** Once the Event Judge has recognized BSP after a landed jump, he may request the Driver to start slowing the towboat.

- (D) **Departure Point.** After each jump the skier shall be dropped into the water and ride back to the departure point in the towboat.

405: DISALLOWED JUMP

A jump shall be disallowed if:

- (A) **BSP Prior to Ramp.** The skier does not attain BSP by the start-of-course gate buoys and/or fails to maintain BSP through the course to the ramp.
- (B) **Tumbleturn.** The skier attempts to recover by a greater than 90-degree tumbleturn after the skier has gone over the ramp, and before BSP has been recognized.
- (C) **BSP after Ramp.** The skier does not attain BSP before the end-of-course buoy.
- (D) **Exceeding Maximum Speed.** The towboat speed through the jump course is judged to have exceeded 73.5 kph/45.7 mph as checked by a GPS speed-measuring device while the skier is in possession of the handle **and prior to BSP being recognized after the jump.**
- (E) **Contact with Ramp.** In the opinion of the Event Judges, the skier advantageously contacts the ramp with anything other than the feet. The Chief Judge can be called upon to adjudicate if the Event Judges are unable to make an immediate ruling.
- (F) **Lose of Helmet.** Skier loses helmet before reaching the jump ramp.

406: SCORING

The skier's longest registered jump distance in a round shall be declared the skier's score for that round.

407: JUMP MEASUREMENT AND CALCULATION

A WBC approved video jump-measurement program shall be used to obtain jump distances. Such a system will not be subject to reading errors, shall produce results that are reproducible on readily available systems, and the distance gleaned from the video will be final.

Note: Approved jump measurement programs are listed in the PPG.

408: DISTANCE

- (A) **Points of Measurement.** Jump distances shall be measured from a point on the surface of the water perpendicularly below the center of the top edge of the ramp, to the point of contact closest to the ramp.
- (B) **Measurement Increments.** Jump distances shall be scored in increments of one-tenth meter.
- (C) **Skier Not Making Landing Box.** In the case of a successful jump that is unreadable due to the skier not making it to the landing box, the distance awarded will be the lowest distance readable on the screen, minus one-tenth meter.
- (D) **Skier Exceeding Landing Box.** In the case of a successful jump that is unreadable due to the skier jumping past the landing box, the distance that will be awarded will be the longest readable distance on the screen, plus one-tenth meter.
- (E) **Malfunction.** Should a malfunction of the jump measuring equipment render an otherwise valid jump to be unreadable, the skier shall be offered an optional re-ride [1003(G)] or the lowest distance readable on the screen, minus one-tenth meter.

409: OFFICIALS

(A) Judges.

- (1) **Boat Judge.** One Event Judge shall ride in the towboat to observe towboat path, course speed, the skier's performance in relation to maintaining BSP from start-of-course buoy, over the ramp, and regaining BSP after the landing before the end-of-course buoy, and Driver's compliance with the skier's instructions.
- (2) **Video Judges.** There shall be two Event Judges stationed at the video monitor who shall agree on the positioning of the cursor. If necessary, they shall use the video replay facility to determine the landing point. If the two Event Judges fail to agree, a third Appointed Judge shall be called in and he will position the cursor himself. The median value among the three distance readouts shall be taken as the official jump distance.
- (3) **Agreement.** By observing the speed measuring devices the Driver and Boat Judge shall both agree that the skier received their requested speed through the course.

(B) **Speed Adjudicator.** Where a speed control system is not used, a Speed Adjudicator shall ride in the towboat to verify the boat speed via GPS. In the event of a disagreement between the Driver and Boat Judge, the speed recorded on the Speed Adjudicator's GPS shall be used.

(C) **Safety Swimmer.** A safety swimmer wearing a life vest and trained in water rescue and a floating stretcher/backboard shall be located adjacent to the jump during the jump event.

CHAPTER 5: SLALOM EVENT

501: PASSES

The skier shall attain BSP by any start trick listed in 604 and the skier may reverse direction before starting the pass.

- (A) **Two 15-Second Passes.** In each round, each skier shall be allowed two 15-second passes, with no more than one pass in backward BSP, through the Slalom course, during which the skier can earn points
- (B) **Two Forward Passes.** If both passes are in forward BSP or any portion of a pass is made in forward BSP, then the points for the lower-scoring forward pass or portion of the forward pass shall be calculated at 25 percent of the scored value rounded to two decimal places (.01).

- (C) **Combination Backward/Forward Pass.** If during a backward pass a skier, for whatever reason, changes to the forward position, the skier can recommence crossing forward and receive credit for those forward crossings as set out in 501(B).

502: START OF RECORDING

- (A) **First Movement.** The Boat Judge(s) shall start the audible timing device and recording at the skier's first movement toward the wake from BSP outside the wake.
 - (1) **Away from Wake.** If the skier skis away from the wake before starting to cross (i.e. to attack the wake or gain momentum), this will not be held to be a first movement toward the wake, and the pass will not start until the skier turns back toward the wake.

Table 501(B). Forward Slalom Pass Value after 25% Multiplier Applied

Score	Applied	Score	Applied	Score	Applied	Score	Applied
0.1	0.03	2.1	0.53	4.1	1.03	6.1	1.53
0.2	0.05	2.2	0.55	4.2	1.05	6.2	1.55
0.3	0.08	2.3	0.58	4.3	1.08	6.3	1.58
0.4	0.10	2.4	0.60	4.4	1.10	6.4	1.60
0.5	0.13	2.5	0.63	4.5	1.13	6.5	1.63
0.6	0.15	2.6	0.65	4.6	1.15	6.6	1.65
0.7	0.18	2.7	0.68	4.7	1.18	6.7	1.68
0.8	0.20	2.8	0.70	4.8	1.20	6.8	1.70
0.9	0.23	2.9	0.73	4.9	1.23	6.9	1.73
1.0	0.25	3.0	0.75	5.0	1.25	7.0	1.75
1.1	0.28	3.1	0.78	5.1	1.28	7.1	1.78
1.2	0.30	3.2	0.80	5.2	1.30	7.2	1.80
1.3	0.33	3.3	0.83	5.3	1.33	7.3	1.83
1.4	0.35	3.4	0.85	5.4	1.35	7.4	1.85
1.5	0.38	3.5	0.88	5.5	1.38	7.5	1.88
1.6	0.40	3.6	0.90	5.6	1.40	7.6	1.90
1.7	0.43	3.7	0.93	5.7	1.43	7.7	1.93
1.8	0.45	3.8	0.95	5.8	1.45	7.8	1.95
1.9	0.48	3.9	0.98	5.9	1.48	7.9	1.98
2.0	0.50	4.0	1.00	6.0	1.50	8.0	2.00

- (2) **Drifting into Wake.** Drifting into the curl of the wake following the start is not to be considered a first movement toward the wake

(B) Testing Speed. Positioning tricks or testing the speed with a one-foot need not be declared.

503: END OF PASS

If the towboat passes the shutdown buoy before the 15 seconds have elapsed, the Driver shall smoothly close the throttle and maintain a safe path until the towboat stops. The skier is free to continue executing crossing while the towboat is slowing down and the Event Judges will continue to record them, noting when the timing device sounds the end of the 15 seconds.

504: CREDIT

(A) Skier Responsibility. It is responsibility of the skier to show the Event Judge(s) that he has fully crossed the wake in BSP.

(B) Two-Foot Crossing.

- (1) **Full.** A perfect two-foot crossing is credited when the skier has crossed the wake in two-foot BSP in accordance with 504(D)(1)(a).
- (2) **Partial.** The skier will receive credit for a partial two-foot crossing in accordance with 505(A)(1)(b) when the:
- Crossing in progress is interrupted by the expiry of time.
 - In the case of a skier losing the handle during a crossing, the skier shall receive credit for a two-foot crossing up to the point of losing BSP.

(C) One-Foot Crossing.

- (1) **Full.** A perfect one-foot crossing is credited in accordance with 504(D)(2)(a) when the skier has crossed the wake in BSP with the lifted foot/leg completely clear of the water before the lift-off point of the first wake wave and remains completely clear of the water until the skiing foot has passed the lift-off point of the second wake wave. The skier shall hold the lifted foot high enough so that it can be seen from the towboat without doubt to be clear of the water.

- (2) **Partial.** A partial one-foot crossing shall only be credited, in accordance with 504(D)(2)(b), if it is part of a perfect one-foot crossing during which the 15-second period expires.

(D) Points Scored. Points shall be awarded for full and partial crossings made during the pass as follows:

(1) Two-Foot Crossings.

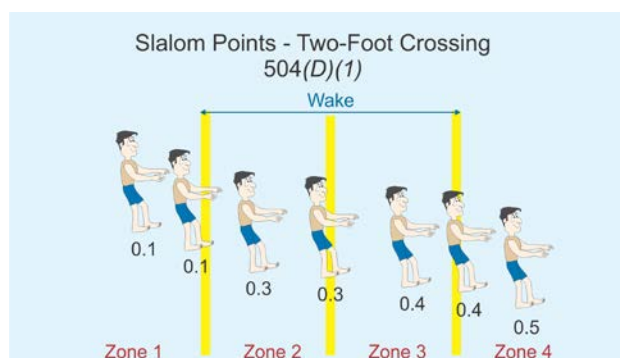

- A full two-foot crossing in accordance with 504(B)(1) shall be scored as 0.5 points (Zone 4).
- A partial two-foot crossing Judged in accordance with 504(B)(2) shall be scored as follows:
 - 0.1 points if the skier is in movement toward the wake, but not yet having past the lift-off point of the first wake wave with both feet (Zone 1).
 - 0.3 points if the skier has passed the lift-off point of the first wake wave but has not passed the center of the wake with both feet (Zone 2).
 - 0.4 points if the skier has passed the center of the wake but has not passed the lift-off point of the second wake wave with both feet (Zone 3).

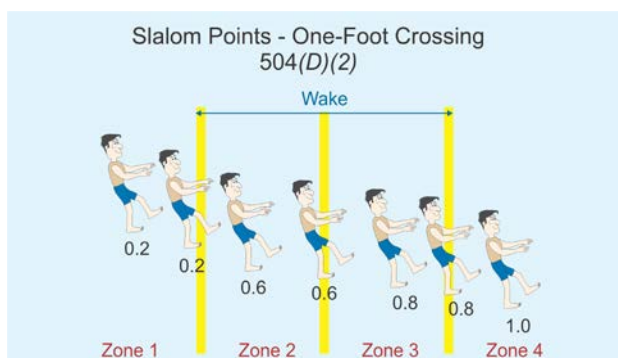
(2) **One-Foot Crossings.**

(a) A perfect one-foot crossing, in accordance with 504(C)(1), shall be scored as 1.0 points (Zone 4).

(b) A partial one-foot crossing, in accordance with 504(C)(2), shall be scored as follows:

(1) 0.2 points if the skier is in movement toward the wake, but not yet having past the lift-off point of the first wake wave with the supporting foot (Zone 1).

(2) 0.6 points if the skier has passed the lift-off point of the first wake wave but has not passed the center of the wake with the supporting foot (Zone 2).

(3) 0.8 points if the skier has passed the center of the wake but has not passed the lift-off point of the second wake wave with the supporting foot (Zone 3).

(c) An imperfect one-foot crossing shall be scored as a two-foot crossing in accordance with 504(D)(1).

(E) **Scoring Zero.** The crossing in which the skier is engaged shall score zero if:

(1) **Loses BSP.** The skier loses BSP during the crossing but retains the handle, e.g. sit or fall/tumble up.

(2) **Crossing Back.** The skier turns back during the crossing without having crossed over the entire wake in BSP. The skier may continue crossings and scoring re-commences only from BSP outside the wake.

505: SCORING

(A) **Simple Majority.** The Scorers shall receive the score sheet(s) and decide the crossings to be scored, based on a majority from among the Event Judges' individual score sheets. Points shall be awarded for full and partial crossings made during the pass as set out in 504.

(B) **Imperfect One-Foot Crossing.** Downgrading an imperfect one-foot crossing to a two-foot crossing requires a majority of two or more Event Judges agreeing on the same fault zone for that crossing. The three fault zones shall be as follows:

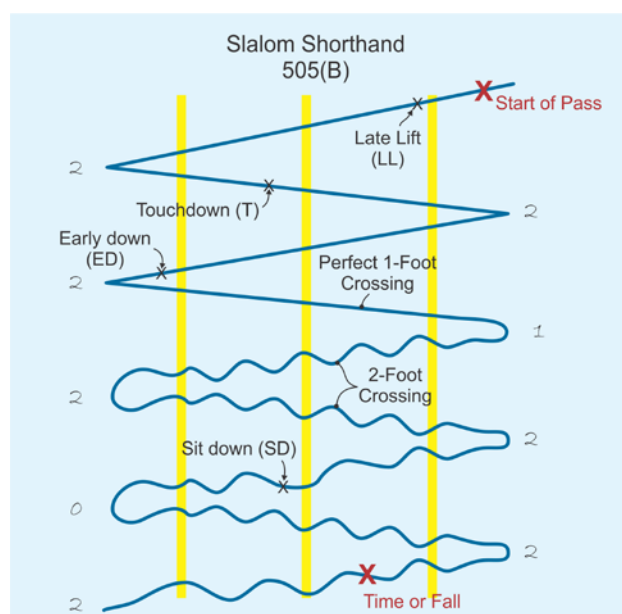

(1) **Late Lift (LL).** A late lift shall be recorded when the skier's lifted foot touches the water surface between the lift-off points before the supporting foot reaches the first lift-off point of the wake wave.

(2) **Touch (T).** A touch shall be recorded when the skier's lifted foot touches the water surface between the lift-off points while the supporting foot is between the lift-off points of the wake waves.

(3) **Early Down (ED).** An early down shall be recorded when the skier's lifted foot touches the water surface beyond the second lift-off point while the supporting foot has yet to clear the second lift-off point of the wake waves.

(C) No Majority. In the case of no majority on any fault zone of a one-foot crossing, the crossing shall score as a one-foot crossing.

(D) Expiration of Time. The end of scoring zone shall be determined by a majority of two or more Event Judges agreeing on the same zone.

(1) In the case of three Event Judges recording three different zones for the end of scoring zone, the end of scoring zone shall be determined from video review.

(2) Where video is not available for review, the end of scoring zone shall be determined by the highest zone that has an agreement between two Event Judges.

Note: If Judge 1 has Zone 1, Judge 2 has Zone 2 and Judge 3 has Zone 3, Judge 2 and Judge 3 have both agreed the skier has at least achieved Zone 2 so the highest agreed scoring end of scoring zone is Zone 2.

506: OFFICIALS

(A) Recording. Event Judge(s) shall watch and using slalom shorthand [505(B)], shall record independently the identity and success of each crossing made by the skier as it's performed and note the exact position of the skier at the start and end of the pass.

(B) Continue Recording. Event Judge(s) shall continue to record crossings made after the expiry of the 15 seconds, regardless of speed or path of the towboat.

(C) After Pass Ends. Supplements to this record for which there was insufficient opportunity during the pass or the correction of writing errors or misconceptions can be made after the pass ends, but only before the sheet is discussed for scoring in the boat or handed over to the Scorers, except as permitted in video review [1303(A)].

(1) Additions or corrections shall not be made to the score sheet once the sheet has been discussed or handed over to the Scorers.

(2) Except as permitted in 506(E) or 1010, there shall not be any communication of the score sheets with the other Event Judges until after the event's protest period has expired.

(D) Judging. The Event Judge(s) shall independently decide and record with respect to each crossing the following:

(1) Where the crossing started and ended.

(2) Whether the crossing was a two-foot, imperfect one-foot, or perfect one-foot crossing.

(3) If the crossing was an imperfect one-foot crossing i.e. the skier lifted up late, touched down between the lift-off points of the wake, or put down early, this shall be clearly marked on the score sheet at the place where it occurs.

(4) Whether the crossing was a partial one-foot or partial two-foot crossing.

(5) The reason for the ending if a partial crossing.

(6) If the crossing was performed according to the rules.

(E) Boat Scoring. When authorized by the Chief Judge and only after completing their sheets, the Event Judges shall communicate with each other to arrive at a majority and to convey that provisional score to the Scorer.

CHAPTER 6: START TRICKS

601: GENERAL

- (A) Number of Passes.** In each round, each skier shall be allowed two passes through the tricks course during which the skier can earn start points at the beginning of each pass.
- (B) One Attempt.** BSP from all start tricks shall be accomplished in only one attempt.
- (1) The skier may stall or hesitate after the initial foot/feet plant, but shall not be allowed to lose that plant and replant the foot/feet for credit.
 - (2) Once the skier has raised himself from the surface of the water, the skier is not permitted to re-sit on the water until after the proper BSP has been recognized.
 - (3) Should the skier fail in this first attempt, the start trick shall not score even if the trick is subsequently completed.
- (C) Skier Persists.** The skier is permitted to persist with the start until the towboat passes the shut-down buoy and comes to rest.
- (D) Credited.** The skier shall only be credited with the start trick attempted, unless that start is downgraded.

Example: If the skier fails a rope on foot start they cannot receive credit for any other start once they have commenced the rope on foot start.

- (E) Lifted Foot.** During a one-foot start, the lifted foot shall not support the weight of the skier before one-foot BSP has been recognized. If, in the opinion of the event judge(s), the lifted foot becomes a supporting foot before one-foot BSP has been recognized, the start shall be downgraded to the two-foot start if the criteria of the two-foot version in accordance with 604 was satisfied.

602: SCORING

To receive credit for two starts in a round, the skier shall successfully perform two different starts listed in the Start Points Table.

Start Points - 602				
	Two Feet	One Foot	Flyer Bonus	Tower Bonus
Front Deep	50	100	50	150
Front Toe-Up		400		
Front Tumble	100	150	50	100
Back Deep	200	500	100	200
Back Toe-Up		450		
Back Tumble	400	700	100	200

- (A) Successful Start.** The points for a successful start trick will be credited whether or not the subsequent trick pass is credited.
- (B) Failed Start.** A failed start trick does not affect the scoring of subsequent pass trick.
- (C) Repeated Two-Foot Start.** Where a two-foot start has been repeated, only the higher-paying start will be credited.
- (D) Repeated One-Foot Start.** Where a one-foot start has been repeated:
- (1) The higher-paying start will be credited.
 - (2) The repeated start shall be downgraded to a two-foot start and credited if the criteria of the two-foot version was satisfied.

603: DOCK, TOWER, OR DRY-LAND START (FLYER)

- (A) Dock, Tower, or Dry-Land Start (Flyer).** A dock, tower, or dry-land start (flyer) shall only be permitted on the first pass.
- (B) Towboat Action.**
- (1) **Remain at Starting Dock.** The towboat shall remain at the starting dock, tower, or dry land until the 10-second call.

- (2) **At 10-Second Call.** At the 10-second call from the Boat Official, the towboat shall go into and remain in gear at idle or at requested speed until the “OK” or “STOP” command is received from the skier.

Note: Under no circumstances is the towboat to accelerate away without having received a clear audible “OK” command from the skier. It is better to give a re-ride for a misunderstanding than risk injury to a skier that is not ready skier.

- (C) **Credit Conditions.** To receive credit for a dock, tower, or dry-land (flyer) start, the following shall be complied with:

- (1) **Boat Movement.** The skier’s instructions shall ensure that the towboat is accelerating when he hits the water after leaping off the dock, dry land, or tower.
- (2) **Takeoff.** The skier shall take at least one hop, skip, or step on the dock, tower, or dry land and propel himself up and out from the dock, tower, or dry land; there shall be an instant when the whole of the skier is clearly above the point of takeoff. **During a dry-land start, the skier may contact the water before propelling himself up and out.**
- (3) **Backward Dock or Tower Start.** The skier shall be facing in the direction of travel of the towboat and is not permitted to trail the handle and line between the legs. On signaling his readiness to go by the “OK” command, the skier shall complete the handle pass while he is in the air, while at the same time turning to the backward position prior to landing on to the water.

604: START TRICK DESCRIPTIONS

The skier shall attain BSP by means of any of the following starts:

- (A) **Front Deep-to-Two.** On the “OK” command, the skier shall be pulled feet first up-to-speed according to his instructions with his body facing upwards. He shall then place both feet onto the water and raise himself to forward BSP.

- (B) **Front Deep-to-One.** On the “OK” command, the skier shall be pulled feet first up-to-speed according to his instructions with his body facing upwards. He shall then place one foot onto the water and raise himself to forward to one-foot BSP. The lifted foot shall not support weight of the skier before one-foot BSP has been recognized. If the skier fails to satisfy 601(E) before one-foot BSP has been recognized the start shall be downgraded to a front deep-to-two provided it meets the requirements of 604(A).

- (C) **Back Deep-to-Two.** On the “OK” command, the skier shall be pulled feet first up-to-speed according to his instructions with his body facing downwards and the handle held behind his back. He shall then place both feet onto the water and raise himself to backward BSP.

- (D) **Back Deep-to-One.** On the “OK” command, the skier shall be pulled feet first up-to-speed according to his instructions with his body facing downwards and the handle held behind his back. He shall then place one foot onto the water and raise himself to backward one-foot BSP. If the skier fails to satisfy 601(E) before one-foot BSP has been recognized the start shall be downgraded to a back deep-to-two provided it meets the requirements of 604(C).

- (E) **Front Tumble-to-Two.** On the “OK” command, the skier shall be pulled headfirst with his legs trailing behind him up-to-speed according to his instructions. The skier may come out of deep water on either his stomach or back. While on his back, the skier shall then swing his legs round from the trailing position to the forward position and raise himself to forward two-foot BSP. During the rotation the skier may hesitate, pause, **overshoot, or reverse direction.**

- (F) **Front Tumble-to-One.** On the “OK” command, the skier shall be pulled headfirst with his legs trailing behind him up-to-speed according to his instructions. The skier may come out of deep water on either his stomach or back. While on his back, the skier shall then swing his legs round from the trailing position to the forward position and then place one foot onto the water and raise himself to forward one-foot BSP.

During the rotation the skier may hesitate, pause, **overshoot, or reverse direction**. If the skier fails to satisfy 601(E) before one-foot BSP has been recognized the start shall be downgraded to a front tumble-to-two provided it meets the requirements of 604(E).

(G) Back Tumble-to-Two. On the “OK” command, the skier shall be pulled headfirst, on his back, side or front, with his legs trailing behind him while holding the handle behind his back, up-to-speed according to his instructions. While on his stomach the skier shall swing his legs round from the trailing position to the forward position and raise himself to backward two-foot BSP. During the rotation the skier may hesitate, pause, **overshoot, or reverse direction**.

(H) Back Tumble-to-One. On the “OK” command, the skier shall be pulled headfirst, on his back, side or front, with his legs trailing behind him while holding the handle behind his back, up-to-speed according to his instructions. While on his stomach the skier shall swing his legs round from the trailing position to the forward position and raise himself to backward one-foot BSP. During the rotation the skier may hesitate, pause, **overshoot, or reverse direction**. If the skier fails to satisfy 601(E) before one-foot BSP has been recognized the start shall be downgraded to a back tumble-to-two provided it meets the requirements of 604(G).

(I) Front Rope-on-Foot. On the “OK” command, the skier shall be pulled feet first up-to-speed according to his instructions. His body shall be facing upwards, pulled entirely by the foot in the toe-strap of his handle. Both feet are permitted to touch the toe-strap. He shall then place his free foot onto the water and raise himself into forward rope-on-foot BSP.

The hands are permitted to touch the water surface or spray during the start. The hands shall not touch the handle during the entirety of the start. The skier may steady himself by holding the leg while the towboat accelerates and/or when or rising into BSP. The hands shall be seen to be clear of the handle and the water surface long enough for recognition. Subsequent recovery of the handle is not a requirement.

(J) Back Rope-on-Foot (Toe-Up). On the “OK” command, the skier shall be pulled feet first up-to-speed according to his instructions. His body shall be facing **upward or downward**, pulled entirely by the foot in the toe-strap of his handle. Both feet are permitted to touch the toe-strap. From a position on his stomach, he shall place his free foot onto the water and raise himself in to backward rope-on-foot BSP.

The hands are permitted to touch the water surface or spray during the start. The hands shall not touch the handle during the entirety of the start. The hands shall be seen to be clear of the handle and the water surface long enough for recognition. Subsequent recovery of the handle is not a requirement.

CHAPTER 7: PASS TRICKS—GENERAL REQUIREMENTS

701: PASSES

In each round, each skier shall be allowed two 15-second passes through the tricks course during which the skier can earn pass trick points in accordance with 712.

702: START OF TIME AND RECORDING

(A) First Movement. The Event Judge(s) shall start the 15-second timing device and recording at the skier's first movement toward any pass trick listed in Chapter 8, other than any preparatory tricks declared in accordance with 303(F)

(B) Changing Grip. The action of changing the grip or how the handle is held in preparation for commencing a trick (e.g. taking the handle between the legs in preparation for line position tricks, holding the handle by the toe strap in preparation for neck or teeth tricks) shall never be considered a "first movement" towards a trick.

Note: It is strongly advised that the skier advise the towboat crew of any such actions so as to avoid premature starting of the 15-second timing device.

703: END OF SCORING

(A) Audible Timing Device. The sounding of an audible timing device shall mark the end of the 15-second pass.

(B) Shutdown Buoy. If the towboat passes the shutdown buoy before the 15 seconds have elapsed, the Driver shall smoothly close the throttle and maintain a safe path until the towboat stops. The skier is free to continue executing tricks while the towboat is slowing down and the Event Judges will continue to record them, noting when the timing device sounds the end of the 15 seconds.

704: CREDIT FOR TRICKS

Pass tricks are credited in two phases, according to technical and logical criteria.

(A) Technical Criteria.

- (1) The technical criteria are the descriptions contained in Chapter 8 and are applied by the Event Judges.
- (2) Tricks are assessed in isolation without regard to what happens before or after them.

(B) Logical Criteria. After technical approval, tricks are examined in the light of logical criteria, which involve the relationships to other tricks and the setting of the trick in the two-pass round.

705: SKIER RESPONSIBILITY

(A) Make Action Clear. The skier shall make each action and movement clear to the Event Judge(s), taking into account the distance, water spray, speed of movement and other factors affecting the ability of the Event Judge(s) to discern the prescribed actions when performing a trick.

(B) Maintain BSP. The skier shall display appropriate BSP at the start, during, and the end of all tricks.

(C) Skier Responsibility. It is the skier's responsibility to ensure that any equipment required by the skier for the second pass be placed in the towboat prior to the first pass.

706: LOSS OF BSP

(A) Fall During Trick. If a skier falls prior to the trick being recognized, the trick will not be credited.

(B) Loss of BSP and Recovery via Tumble Turn.

- (1) If the skier loses BSP prior to the trick being recognized and recovers to BSP with less than a 90 degree tumbleturn, the trick may be credited, the tumbleturn recovery shall not be credited and the skier may continue his trick pass.
- (2) If the skier loses BSP prior to the trick being recognized and recovers to BSP with a greater than 90-degree tumbleturn, neither the trick or tumbleturn recovery shall be

credited but the skier may continue his trick pass.

- (3) If the skier loses BSP between tricks due to neither trick but is able to regain BSP, the skier can continue his trick pass.

707: REPEATING FAILED TRICKS

A failed trick may be immediately reattempted until the trick has been credited or time expires. The turn rotation rule 803 does not apply when repeating a failed turn trick.

708: TRICK AFTER EXPIRATION OF TIME

Tricks not completed before the expiry of the 15 seconds shall not be credited and shall not be considered for any reason.

709: REVERSE TRICKS

- (1) A reverse trick shall immediately follow the basic trick.
- (2) A basic and reverse performed in different passes shall not both score.
- (3) The reverse shall not be disallowed simply because it follows an attempted basic trick which has not been credited or because the basic trick is a repeated trick.
- (4) A basic and reverse trick correctly performed, shall be eligible for scoring even if one or both are repeat(s) of trick(s) previously performed in the same or the other pass. Such previously scored trick(s) shall then be annulled unless this conflicts with highest scoring sequence rule 712(B).
- (5) The reverse of a one-foot, one-foot hop, rope-in-teeth one-foot, rope-on-neck one-foot, rope-on-foot, rope on foot turn, sit down-stand up one-foot, or tumbleturn one-foot trick shall be on the opposite foot.

710: SIMULTANEOUS TRICKS

In the event that two tricks are performed simultaneously, only the higher scoring of the two tricks shall score unless that trick has previously been scored, in which case the lower-scoring trick shall score.

711: PRECURSORY TRICKS

(A) One-Foot.

- (1) When executing a one-foot trick, once the skier makes any move toward a hop, rope-on-foot, or one-foot turn, then a one-foot trick shall not be permitted to be credited regardless whatever happens to the subsequent trick.
- (2) Holding one-foot BSP after completing a one-foot trick shall never be paid as a one-foot, whether or not the one-foot trick succeeded.

(B) Rope-on-Foot.

- (1) When executing a rope-on-foot, once the skier makes any move toward a rope-on-foot turn, then a rope-on-foot trick shall not be credited, regardless whatever happens to the subsequent trick.
- (2) Holding rope-on-foot BSP after completing a rope-on-foot turn trick shall never be paid as a rope-on-foot, whether or not the turn trick succeeded.
- (3) To receive credit for a rope-on-foot trick immediately prior to or following a rope-on-foot turn, the foot shall be removed completely from the toe-strap and then replaced to commence the second trick.

712: SCORING—TRICK POINT VALUES

(A) Scoring Process. The Scorers shall receive the score sheets and points shall be awarded for tricks made during the pass in accordance with the Trick Point Values Table 712(A). In the event of a discrepancy, the Scorers shall decide the tricks to be scored on the basis of a majority from among the Event Judge's individual score sheets as to:

- (1) The tricks performed.
- (2) If the tricks were performed according to the logical rules governing those tricks.
- (3) If any downgrades apply.
- (4) The last trick completed before time expired.

(B) Highest Scoring Sequence. The highest scoring sequence of turns that complies with all rotation rules shall be used for scoring a trick pass.

	Trick Point Values - 712(A)				
	Surface Tricks		Wake Tricks		Wake-to Wake
	Two Foot	One Foot	Two Foot	One Foot	
General					
Hop Backward	100*		150§		250§
Hop Forward	20*		30§		100§
Knee Skiing	30				
One Foot Backward		100*			
One Foot Forward		30			
Rope in Teeth	20	50			
Rope on Neck	20	50			
Side Slide - Backward	450§				
Side Slide - Forward	150§				
Side Slide Switch	600§				
Sit Down/Stand Up	20	40			
Somersault (Flip)	500		650		900
Toe Hold Backward		150			
Toe Hold Forward		100			
Tumble 180	50	100			
Tumble 360	50	100			
Wave	10				
Turns - Surface					
180 Back-to-Front	200	350	300	500	500
180 Front-to-Back	250	350	400	500	600
360 Back-to-Back	550	1050	700	1200	900
360 Front-to-Front	450	950	600	1100	800
540 Back-to-Front	750	1350			
540 Front-to-Back	850	1450			
720 Back-to-Back	1050	1850			
720 Front-to-Front	950	1750			
Turns - Step-Over					
Step-Over 180 Back-to-Front	350		500		
Step-Over 180 Front-to-Back	450				
Step-Over 360 Back-to-Back	950				
Step-Over 360 Front-to-Front	850				
Step-Over 540 Back-to-Front	1250				
Step-Over 540 Front-to-Back	1350				
Step-Over 720 Back-to-Back	1850				
Step-Over 720 Front-to-Front	1750				
Turns - Rope-on-Foot					
Toe Back-to-Front		850		1500	
Toe Back-to-Front Toe Start Recovery		300			

***Bonus Trick - 713(A)**
 Hop Forward 1 Foot 50
 Hop Backward 1 Foot 100
 Hop Back 2 Foot Line 100
 Hop Back 1 Foot Line 200
 One-Foot Back Line 100
 § One only i.e. no reverse

(B) Double Credit. A skier cannot be credited with a trick and then credited again with the repeated trick and the bonus. When a skier performs a trick and repeats the trick with the bonus, the skier will only be credited with the bonus points for the repeated trick

714: OFFICIALS

(A) Recording. The Boat Judge(s) shall watch and independently record each trick attempted by the skier and decide with respect to each trick:

- (1) If it was performed in accordance with the technical rules governing that trick.
- (2) If any downgrades apply to the trick.
- (3) If the trick was completed before the end of the pass.

(B) Written Record. The Event Judge(s) shall make a written record, in accordance with the trick shorthand table, of the identity and success or failure of each trick as it's performed. This record shall note the direction of a turn, bonus actions, and on which foot when a one-foot trick has been performed.

Note: Full page view in back of book.

713: BONUS ACTIONS

(A) Bonus Values. The following pass tricks carry a bonus value (basic and reverse one foot only), which are treated as separate from the whole trick and shall be judged and scored as bonuses:

- (1) Hop-Front (one foot)— 50 points*
- (2) Hop-Back (one foot)— 100 points*
- (3) Hop-Back (line BSP)— 100 points
- (4) Hop-Back One Foot (line BSP)—200 points*
- (5) One Foot (line BSP)— 100 points*

*Bonus is permitted for both feet, thus allowing two one-foot hops with bonus credit.

	Tricks Shorthand Table - 714(B)								
	Surface Tricks				Wake Tricks				Wake-to Wake
	Two Foot		One Foot		Two Foot		One Foot		
	Basic	Rev	Basic	Rev	Basic	Rev	Basic	Rev	
General									
Hop	Λ		Λ>	<Λ	Λv				Λw
Knee Skiing	K								
One Foot			>	<					
Rope in Teeth	T		T>	<T					
Rope on Neck	N		N>	<N					
Side Slide-Backward	BSS								
Side Slide-Forward	SS								
Side Slide Switch	SSS								
Sit Down Stand Up	SD		SD>	<SD					
Somersault (Flip)	O				Ov				Ow
Toe Hold			C.	.C					
Tumble 180	⤴	⤵	⤴>	<⤴					
Tumble 360	⤶	⤷	⤶>	<⤶					
Wave	W.	.W							
Turns									
180° Turn	1.	.1	1>	<1	1v	v1	1>v	v<1	1w
360° Turn	3.	.3	3>	<3	3v	v3	3>v	v<3	3w
540° Turn	5.	.5	5>	<5					
720° Turn	7.	.7	7>	<7					
Step Turn 180°	S1	1S			Sv	vS			
Step Turn 360°	S3	3S							
Step Turn 540°	S5	5S							
Step Turn 720°	S7	7S							
Toe Back-to-Front Ft-to-Ft			C1	1C			Cv	vC	
Toe Back-Front Toe Start Rec			C2	2C					
Toe Front-to-Back Ft-to-Ft			C1	1C			Cv	vC	

Note: Full page view in back of book.

(1) Supplements to this record for which there was insufficient opportunity during the pass or the correction of writing errors or misconceptions can be made after the pass ends, but only before the sheet is discussed for scoring in the towboat or handed over to the Scorers, except as permitted in video review [1303(A)].

(a) Additions or corrections shall not be made to the score sheet once the sheet has been discussed or handed over to the Scorers.

(b) Except to determine the last trick in time as permitted in 714(D), to provide provisional results as permitted in 1010 or for in boat scoring as permitted in 714(E), there shall not be any communication of the score sheets with the other Event Judges until after the event's protest period has expired.

(C) Continue Recording. The Boat Judge(s) shall continue to record tricks made after the expiry of the 15 seconds, regardless of speed or path of the towboat.

(D) Last Trick in Time. Between passes, the skier is permitted to ask the Event Judges the last trick in time.

(E) Boat Scoring. If authorized by the Chief Judge, and only after completing their sheets, the Event Judges shall communicate with each other to arrive at a majority and to convey that decision to the Scorer.

715: DOWNGRADES

(A) Tumbleturn Start or Pass Tricks. A one-foot tumbleturn not meeting the one-foot stand up requirements shall downgrade to two-foot tumbleturn provided it has satisfied all criteria for a two-foot tumbleturn [801(G)].

(B) One-foot Turns. Should the skier fail to satisfy the lifted foot requirements before during or after a one-foot turn, that turn shall downgrade to a two-foot turn provided it has satisfied all criteria for a two-foot turn in accordance with Chapter 8.

(C) Wake Tricks.

(1) Wake tricks may downgrade to a surface trick if the wake criteria have not been met, provided it has satisfied all criteria for the surface trick in accordance with Chapter 8.

(2) Wake-to-Wake tricks may downgrade to a wake or surface trick if the wake-to-wake or wake criteria have not been met, provided it has satisfied all criteria for a wake or surface trick in accordance with Chapter 8.

716: ONE ATTEMPT FOR CREDIT

For trick credit, at the conclusion of each trick or trick recovery [706(B)], the skier shall achieve BSP in one attempt and shall meet all of the following requirements:

(A) Foot Plant. The skier may stall or hesitate after the initial foot/feet plant, but is not permitted to lose that plant and replant the foot/feet.

(B) Re-Sit. Once the skier has raised himself from the surface of the water, the skier is not permitted to re-sit on the water until BSP has been recognized.

(C) No Credit. Should the skier replant the foot/feet or re-sit in this first attempt to gain BSP, the pass trick shall not be credited even if the trick is subsequently completed.

CHAPTER 8: PASS TRICK DESCRIPTION

801: GENERAL PASS TRICKS

- (A) **One Hand Wave.** While maintaining BSP, the skier shall release his hand and raise it above the level of the shoulder.
- (B) **Sit Down-Stand Up.**
- (1) **Two Foot.** The skier shall, from BSP, sit down on the water surface, clearly showing his feet to be clear of the water surface and then raise himself to forward BSP.
 - (2) **One Foot.** The skier shall, from BSP, sit down on the water surface, clearly showing his feet to be clear of the water surface. He shall then place one foot onto the water and raise himself to forward one-foot BSP. Basic and reverse shall be allowed in addition to the two-foot version.
- (C) **One-Foot (Forward or Backward).** From two-foot BSP, the skier shall raise one foot and demonstrate forward or backward one-foot BSP.
- (D) **Knee Ski.** From forward BSP, the skier shall go down onto his shins/knees; subsequent recovery of BSP is not a requirement to complete the trick for credit.
- (E) **Rope-on-Neck.**
- (1) **General.**
 - (a) The hands shall be released from the handle and be clearly visible simultaneously.
 - (b) To receive credit for a two-foot rope-on-neck trick in a series, it shall always precede the one-foot tricks.
 - (c) No re-gripping of the handle is permitted in between performing the neck two-foot, one-foot, and reverse tricks.
 - (d) Should the skier re-grip the handle during a series of neck tricks, the skier shall remove the handle from the neck and re-initiate the series to receive credit for the full series of tricks.
 - (2) **Two-Feet.** While using a rope-on-foot trick handle the skier shall place the handle over the head and behind the neck and then the skier shall release the hands completely from any part of the handle or rope while maintaining BSP.
 - (3) **One-Foot.** While maintaining rope-on-neck two-foot BSP, the skier shall raise one foot and demonstrate one-foot BSP.
- (F) **Rope-in-Teeth.**
- (1) **General.**
 - (a) The hands shall be released from the handle and be clearly visible simultaneously.
 - (b) To receive credit for a two-foot rope-in-teeth trick in a series, it shall always precede the one-foot tricks.
 - (c) No re-gripping of the handle is permitted in between performing the teeth two-foot, one-foot and reverse tricks.
 - (d) Should the skier re-grip the handle during a series of teeth tricks, the skier shall remove the handle from the teeth and re-initiate the series to receive credit for the full series of tricks.
 - (2) **Two-Feet.** The skier shall place the teeth piece in his mouth. The skier shall then release the hands from any part of the handle while maintaining BSP.
 - (3) **One-Foot.** While maintaining rope-in-teeth two-foot BSP, the skier shall raise one foot and demonstrate one-foot BSP.
- (G) **Tumbleturns.**
- (1) **General.**
 - (a) The reverse of a tumbleturn two-foot shall be rotated in the opposite direction.

- (b) The reverse of a tumbleturn one-foot shall be both rotated in the opposite direction and to the opposite foot.
- (c) During the rotation of a tumble, the skier may hesitate, pause, overshoot, or **reverse direction**.

(2) **180-Degree Tumbleturn.**

- (a) **Two-Feet.** Commencing from forward BSP, the skier shall lower himself to the water and execute a 180-degree revolution on his back arriving in a head-first position. The 180-degree position is considered achieved when the feet of the skier are judged to have reached or passed the line of the rope. The skier will then stop, and reverse the direction of the turn, return to the forward facing position and regain BSP
- (b) **One-Foot.** The skier shall perform a 180-degree tumbleturn and stand up on one foot to one-foot BSP.

(3) **360-Degree Tumbleturn.**

- (a) **Two-Feet.** Commencing from forward BSP, the skier shall lower himself to the water and execute a 360-degree revolution on his back returning to the forward facing position and regain BSP.
- (b) **One-Foot.** The skier shall perform a 360-degree tumbleturn and stand up on one foot to one-foot BSP.

(H) Hop.

(1) **General**

- (a) **Two-Foot.** The skier shall, from BSP, jump from the surface of the water into the air and land in BSP. During the jump the skier shall be completely clear of the water surface.
- (b) **One-Foot.** Commencing from one-foot BSP the skier shall jump from the surface of the water into the air and land in one-foot BSP. During the jump the skier shall be completely clear of the water surface.

(2) **Wake Hop.**

- (a) **Two-foot.** Commencing from BSP, the skier shall jump over the wake wave and land on the other side of the same wake wave in BSP. A single-wake hop can be performed from either inward or outward; no reverse is permitted.
- (b) **One-foot.** Commencing from one-foot BSP, the skier shall jump over the wake wave and land on the other side of the same wake wave in one-foot BSP. A single-wake hop can be performed from either inward or outward; no reverse is permitted.

(3) **Wake-to-Wake Hop.**

- (a) **Two-foot.** Commencing from BSP outside the wake, the skier shall jump the entire wake and shall be completely clear of the water, landing outside the second wake crest in BSP. No reverse is permitted.
- (b) **One-foot.** Commencing from one-foot BSP outside the wake, the skier shall jump the entire wake and shall be completely clear of the water landing outside the second wake crest in one-foot BSP. No reverse is permitted.

- (I) Rope-on-Foot.** Commencing from BSP, the skier shall place one foot in the toe-strap. With his weight supported by the foot on the water, the skier shall then release his hands completely from any part of the handle so that the handle is held only by the lifted foot, in accordance with rope-on-foot BSP. The hands shall be seen to be clear of the handle and the water surface long enough for recognition. Subsequent recovery of the handle is not a requirement.

(J) Side-Slide.

- (1) **Forward.** Commencing from forward BSP, the skier shall rotate in one continuous movement to side-slide BSP.
- (2) **Backward.** Commencing from backward BSP, the skier shall rotate in one continuous movement to side-slide BSP.

(K) Switch-Stance. Commencing from Side-Slide BSP, the skier shall slide both feet to the opposite position and then back to the original side-slide BSP position.

Note: Following a side-slide trick, once side-slide BSP has been recognized, the skier is allowed to immediately commence a switch-stance trick and may receive credit for both tricks.

(L) Wake Tricks. Any rotation of a wake trick shall be completed in midair during a jump over the wake wave. The skier shall land on the other side of the wake crest in BSP.

- (1) The skier shall remain completely clear of the water surface during the entire trick or turn.
- (2) While executing a wake trick, the skier may use the whole of the upslope and ski through the crest of the wave to propel himself into the air.
- (3) Wake rope-on-foot turns shall take off and land on the foot. Water contact with any body part before the foot will disallow the trick.

(M) Wake-To-Wake Tricks.

- (1) A wake-to-wake trick is a trick performed in the air during a jump over the entire wake wave.
- (2) The skier may use the whole of the upslope and ski through the crest of the wave to propel himself into the air.
- (3) The skier shall jump high enough to bridge the entire wake and shall be completely clear of the water till clearing the second wake crest, landing outside the second wake crest on his feet. Water contact with any body part before the foot/feet will disallow the trick.

802: TURN TRICKS GENERAL

(A) Opposite Direction. The reverse of a turn trick shall be in the opposite direction of rotation of the basic.

(B) Between 180- or 540-Degree Turns. Any variety of 180-degree or 540-degree turn is allowed between 180-degree or 540-degree basic and reverse turns.

(C) Skier Touching Handle with Both Hands. The completeness of all surface, wake, and wake to wake turns shall be judged with the skier touching the handle with both hands whilst displaying the appropriate BSP.

(D) Continuous Turning Movement. In a multiple-turn any interruption in the continuous turning movement shall terminate the trick at that point and it shall score zero. A variation in the speed of rotation shall not constitute an interruption of the turn.

(E) Maximum Multiple Surface Turns. No more than eight one-foot and eight two-foot multiple-surface-turns shall be scored in any round.

(F) Maximum Step-Over Turns. No more than four step-over multiple-turns shall be scored in any round.

(G) One-Foot Turns. One-foot turns shall start, maintain, and end in one-foot BSP.

803: ROTATION RULE FOR SURFACE-TURNS

(A) Consecutive Surface Turn Tricks.

- (1) When any surface turn immediately follows any other surface turn, **the rotation shall be in the opposite direction of the previous turn**, except for reverse 540 and 180 turns, which can only be in the same rotation as the positional turn.
- (2) If a skier makes consecutive surface turns in the same direction with no other trick in between, they shall be treated as a multiple-turn and shall meet the criteria for that trick to be credited.
- (3) This requirement does not apply when the skier ends an attempted one-foot turn in one-foot BSP and then sets his foot down and raises it again for a further one-foot turn attempt.

(B) Consecutive Step-Over Turn Tricks.

- (1) When a step-over turn immediately follows another step-over surface turn, the rotation shall be in the opposite direction of the previous turn, except for reverse 540 and 180 turns, which can only be in the same rotation as the positional turn.
- (2) If the skier makes consecutive step-over turns in the same direction with no other trick in between, they will be treated as a multiple-turn and shall meet the criteria of that trick to be credited.

804: 180 BACK-TO-FRONT**(A) Surface 180 Back to Front.**

- (1) **Two-Feet.** Commencing from backward BSP, the skier shall execute a 180-degree turn to forward BSP.
- (2) **One-Foot.** Commencing from backward one-foot BSP the skier shall execute a 180-degree turn to forward one-foot BSP.

(B) Wake 180 Back to Front.

- (1) **Two-Feet.** Commencing from backward BSP the skier shall execute a 180-degree in accordance with 801(L), landing in forward BSP.
- (2) **One-Foot.** Commencing from backward one-foot BSP, the skier shall execute a 180-degree turn in accordance with 801(L), landing in forward one-foot BSP.

(C) Wake-to-Wake 180 Back-to-Front.

- (1) **Two-Foot.** Commencing from backward BSP outside the wake the skier shall execute a 180-degree turn in accordance with 801(M), landing in forward BSP.
- (2) **One-Foot.** Commencing from backward one-foot BSP, outside the wake the skier shall execute a 180-degree turn in accordance with 801(M), landing in forward one-foot BSP.

805: 180 FRONT-TO-BACK**(A) Surface 180 Front-to-Back.**

- (1) **Two-Feet.** Commencing from forward BSP, the skier shall execute a 180-degree turn to backward BSP.
- (2) **One-Foot.** Commencing from forward one-foot BSP the skier shall execute a 180-degree turn to backward one-foot BSP.

(B) Wake 180 Front-to-Back.

- (1) **Two-Feet.** Commencing from forward BSP, the skier shall execute a 180-degree in accordance with 801(L), landing in backward BSP.
- (2) **One-Foot.** Commencing from forward one-foot BSP, the skier shall the skier shall execute a 180-degree in accordance with 801(L), landing in backward one-foot BSP.

(C) Wake-to-Wake 180 Front-to-Back.

- (1) **Two-Feet.** Commencing from forward BSP, the skier shall execute a 180-degree turn in accordance with 801(M), landing in backward BSP.
- (2) **One-Foot.** Commencing from forward one-foot BSP, the skier shall execute a 180-degree turn in accordance with 801(M), landing in backward one-foot BSP.

806: 360 FRONT-TO-FRONT**(A) Surface 360 Turns.**

- (1) **Two-Feet.** Commencing from forward BSP, the skier shall execute a continuous 360-degree turn, returning to forward BSP.
- (2) **One-Foot.** Commencing from forward one-foot BSP, the skier shall execute a continuous 360-degree turn returning to forward one-foot BSP.

(B) Wake 360 Front-to-Front.

- (1) **Two-Feet.** Commencing from forward BSP, the skier shall execute a 360-degree turn in accordance with 801(L), landing in forward BSP.
- (2) **One-Foot.** Commencing from forward one-foot BSP, the skier shall execute a 360-degree turn in accordance with 801(L), landing in forward one-foot BSP.

(C) Wake-to-Wake 360 Front-to-Front.

- (1) **Two-Feet.** Commencing from forward BSP, the skier shall execute a 360-degree turn in accordance with 801(M), landing in forward BSP.
- (2) **One-Foot.** Commencing from forward one-foot BSP, the skier shall execute a 360-degree turn in accordance with 801(M), landing in forward BSP.

807: 360 BACK-TO-BACK**(A) Surface 360 Back-to-Back.**

- (1) **Two-Feet.** Commencing from backward BSP, the skier shall execute a continuous 360-degree turn, returning to backward BSP.
- (2) **One-Foot.** Commencing from backward one-foot BSP, the skier shall execute a continuous 360-degree turn, returning to backward one-foot BSP.

(B) Wake 360 Back-to-Back.

- (1) **Two-Feet.** Commencing from backward BSP, the skier shall execute a 360-degree turn in accordance with 801(L), landing in backward BSP.
- (2) **One-Foot.** Commencing from backward one-foot BSP, the skier shall execute a 360-degree turn in accordance with 801(L), landing in backward one-foot BSP.

(C) Wake-to-Wake 360 Back-to-Back.

- (1) **Two-Foot.** Commencing from backward BSP outside the wake, the skier shall execute a 360-degree turn in accordance with 801(M), landing in backward BSP.
- (2) **One-Foot.** Commencing from backward one-foot BSP outside the wake, the skier shall execute a 360-degree turn in accordance with 801(M), landing in backward one-foot BSP.

808: 540 TURNS**(A) Surface 540 Back-to-Front.**

- (1) **Two-Feet.** Commencing from backward BSP, the skier shall execute a continuous 540-degree turn to forward BSP.

- (2) **One-Foot.** Commencing from backward one-foot BSP, the skier shall execute a continuous 540-degree turn to forward one-foot BSP.

(B) Surface 540 Front-to-Back.

- (1) **Two-Feet.** Commencing from forward BSP, the skier shall execute a continuous 540-degree turn to backward two-foot BSP.
- (2) **One-Foot.** Commencing from forward one-foot BSP, the skier shall execute a continuous 540-degree turn to backward one-foot BSP.

809: 720 TURNS**(A) Surface 720 Front-to-Front.**

- (1) **Two-Feet.** Commencing from forward BSP, the skier shall execute a continuous 720-degree turn, returning to forward BSP.
- (2) **One-Foot.** Commencing from forward one-foot BSP, the skier shall execute a continuous 720-degree turn, returning to forward one-foot BSP.

(B) Surface 720 Back-to-Back.

- (1) **Two-Feet.** Commencing from backward BSP, the skier shall execute a continuous 720-degree turn, returning to backward BSP.
- (2) **One-Foot.** Commencing from backward one-foot BSP, the skier shall execute a continuous 720-degree turn, returning to backward one-foot BSP.

810: STEP-OVER TURN**(A) General.** For credit of a step-over line turn, all of the following conditions shall be met:

- (1) **Leg Over Rope.** One leg passes over the rope simultaneous to the turn.
- (2) **Completion.** The skier shall touch the water with the foot that passed over the rope whilst displaying the appropriate BSP.
- (3) **Accidental Contact.** Accidental contact with the rope or spray during the step over will not disallow the trick.

(B) Wake-Turn. In a step-over wake turn the leg shall pass over the rope and the turn shall be completed while the skier is in the air.

(C) Multiple Step-Over.

- (1) In a multiple-step-over-turn both legs shall pass over the rope in succession, changing feet at mid-point.

(D) Step-Over Tricks

- (1) **180 Step-Back-to-Front.** Commencing from line BSP, the skier shall simultaneously execute a 180-degree turn while stepping over the rope to forward BSP.
- (2) **Wake 180 Step-Back-to-Front.** Commencing from line BSP, the skier shall simultaneously jump over the wake wave, step over the rope, and turn 180-degrees commencing from the air, landing on the far side of that wake wave in forward BSP.
- (3) **180 Step-Front-to-Back.** Commencing from forward BSP, the skier shall simultaneously execute a 180-degree turn while stepping over the rope to line BSP.
- (4) **Wake 180 Step-Front-to-Back.** Commencing from forward BSP, the skier shall simultaneously jump over the wake wave, step over the rope, and turn 180-degrees commencing from the air, landing on the far side of that wake wave in line BSP.
- (5) **360 Step-Back-to-Back.** Commencing from BSP, the skier shall execute a continuous 360-degree turn, simultaneously stepping over the rope as he goes from back to front and again as he comes from front to back, returning to line BSP.
- (6) **360 Step-Front-to-Front.** Commencing from forward BSP, the skier shall execute a continuous 360-degree turn, simultaneously stepping over the rope as he goes from front to back and again as he comes from back to front, returning to forward BSP.
- (7) **540 Step-Back-to-Front.** Commencing from line BSP, the skier shall execute a continuous 540-degree turn, simultaneously stepping over the rope as he goes from back to front, front to back, and back to front, returning to forward BSP.
- (8) **540 Step-Front-to-Back.** Commencing from forward BSP, the skier shall execute a continuous 540-degree turn, simultaneously stepping over the rope as he goes from front to back, back to front, and front to back, returning to line BSP.
- (9) **720 Step-Back-to-Back.** Commencing from line BSP, the skier shall execute a continuous 720-degree turn, simultaneously stepping over the rope as he goes from back to front, front to back, back to front, and front to back, returning to line BSP.
- (10) **720 Step-Front-to-Front.** Commencing from forward BSP, the skier shall execute a continuous 720-degree turn, simultaneously stepping over the rope as he goes from front to back, back to front, front to back, and back to front, returning to forward BSP.

811: ROPE-ON-FOOT TURN FEET-TO-FEET

- (A) Back-to-Front.** Commencing from backward rope-on-foot BSP, the skier shall execute a 180-degree turn to forward rope-on-foot BSP.
- (B) Front-to-Back.** Commencing from forward rope-on-foot BSP, the skier shall execute a 180-degree turn to backward rope-on-foot BSP.
- (C) Taking Handle.** Taking the handle before the trick has been recognized shall disallow the trick.
- (D) Feet-to-Feet.** The trick shall be performed feet to feet until recognized for credit.

812: ROPE-ON-FOOT TURN TOE-START RECOVERY

- (A) Back-to-Front.** Commencing from backward rope-on-foot BSP, the skier shall execute a 180-degree turn to the forward position and shall stand up to regain rope-on-foot BSP from a seated position. The skier's hands must be clear of the handle throughout the trick.
- (B) Taking Handle.** Taking the handle before the trick has been recognized shall disallow the trick.

813: SOMERSAULT

(A) General.

- (1) To receive credit, the plane of rotation shall be vertical like a fan blade, so that during the somersault the heels pass directly over the head. It shall be noted that although the plane of rotation shall be vertical, it's permitted to be inclined to the towboat path.
- (2) In a wake somersault, after take-off, no part of the body shall touch the water on the take off side of the wake until the trick has been held for recognition.
- (3) In a wake-to-wake somersault, after take-off, no part of the body shall touch the water inside the wake until the trick has been held for recognition. A failed wake-to-wake somersault can be credited as a wake somersault providing it meets the criteria in 813(A)(1)(2).
- (4) Wake somersaults shall be performed from inside to outside of the wake except in the case of 715(C)(2).
- (5) A maximum of three somersaults can be scored in any round.
- (6) A reverse somersault is NOT allowed.
- (7) Reverse wake somersaults shall only be performed from the inside to the outside of the opposite wake of the basic trick.
- (8) A reverse wake-to-wake somersault shall be performed in the opposite direction to the basic trick.

(B) Somersault Tricks.

- (1) **Somersault.** Commencing from forward BSP, the skier shall perform a somersault (heels over head) in the air, landing on the skier's feet, butt, back or head, whereupon he shall regain BSP
- (2) **Wake Somersault.** Commencing from forward BSP inside the wake the skier shall perform a somersault while jumping over one wake wave, landing on the other side of the same wake wave.
- (3) **Wake-to-Wake Somersault.** Commencing from forward BSP outside the wake the skier shall perform a somersault while jumping over the entire wake, landing on the outside of the second wake wave.

CHAPTER 9: PROTESTS

901: PROTEST BASIS

Protests shall only be permitted for the failure of an official or Tournament Committee to comply with the rules contained in this rule book. Necessary changes to the course due to safety issues encountered after the start of the tournament shall never be grounds for a protest.

902: PROTEST PROCEDURE

Protests shall be filed by the Team representative to the Chief Judge in written form and shall comply with all of the following requirements:

- (A) **General Protests.** A written protest for a failure of tournament officials, tournament supplied equipment or the tournament committee may be filed up to 30 minutes after the event results have been officially posted.
- (B) **Protest of Safety.** A written protest for safety issues may be filed at any time.
- (C) **Protest Fee.** The written protest shall be accompanied by the approximate equivalent in U.S. currency of \$20 (USD). The protest fee will be refunded if the protest is considered reasonable by the Chief Judge, even if the protest is disallowed.
- (D) **Content of Written Protest.** The written protest shall cite the rule number(s) that apply and the facts pertaining to the protest.

903: CHIEF JUDGE DECISION

- (A) **Chief Judge Authority.** After the Chief Judge has been made aware of all the facts pertaining to a decision made by any official, the Chief Judge may then overrule that decision in order to ensure compliance with all rules.
- (B) **Use of Evidence.** The Chief Judge is free to use any and all evidence he feels is applicable to effect an expeditious and correct decision.

- (C) **Communicate Decision.** The Chief Judge shall communicate this decision to the officials, skiers, and team managers involved citing all of the rules used to reach this decision.

904: REVERSE CHIEF JUDGE DECISION

Any decision taken by the Chief Judge to overrule any official(s) in accordance with 903 may be reversed providing all of the following requirements have been met:

- (A) **Filing.** The written reversal protest shall be filed within 30 minutes after event has concluded or 30 minutes after the Chief Judges' decision to overrule any official(s) have been posted, whichever is later.
- (B) **Content of Written Protest.** The reversal protest shall contain the rule number(s) that the Chief Judge has violated.
- (C) **Decision.** The Chief Judge shall as soon as practical, present the reversal protest to all Appointed Officials, the Chief Judge shall make the Appointed Officials cognizant of the facts when presenting the protest to them for consideration, i.e. present his overrule decision with the rule numbers cited and the reversal protest with the rule numbers cited.
- (D) **Two-Thirds.** Two-thirds of all Appointed Officials are required to vote in favor to reverse the Chief Judge's decision to overrule any official(s).
- (E) **Decision Posting.** Any vote that reverses the Chief Judge's decision to overrule any official(s) shall be posted as soon as possible.

905: CALCULATION ERROR

- (A) **Within Two Hours of Postings.** A request by a Team Representative for a correction of an error in the computation or input of a score within 2 hours of the posting of the event results shall not be considered a protest and a correction shall be made with the approval of the Chief Judge and Chief Scorer.

- (B) **Within One-Half Hour of Next Round.** A correction of an error in the computation or input of a score discovered by the Chief Judge or Chief Scorer may be corrected up to one-half hour before the start of the next round of that event.
- (C) **Semifinals.** Any skier displaced from the semifinals resulting from a correction of an error in computation or input of a score shall go on to the semifinal round.
- (D) **Finals.** No more than five skiers shall be permitted to advance to the final round [1910], therefore any skier displaced resulting from a correction of an error in the computation or input of a score shall not go to the final round.

CHAPTER 10: RE-RIDES

1001: RE-RIDE REQUEST

- (A) **Initiated by Event Judge or Driver.** Requests for re-rides shall be initiated by an Event Judge or Driver before the next skier starts and shall be decided as soon as practicable thereafter. The Video Operator is permitted to offer information that may have escaped the notice of the Event Judges.
- (B) **Skier or Team Representative.** The Team Representative or skier is free to draw the attention of the Event Judges to some relevant condition or circumstance affecting the granting of a re-ride that may have escaped their notice. The Event Judges shall consider such submission and act on it or not as they see fit. The Event Judges shall maintain the strictest vigilance to ensure the interests of the skier are fully respected.
- (C) **Majority.** A re-ride shall be granted when a majority of the Event Judges agree that the skier is entitled to a re-ride.
- (D) **Not to Proceed.** The Event Judges shall not proceed with the next pass unless a simple majority of them have indicated that nothing was wrong with the last pass, making an appropriate entry in the tick box on the score sheet.

1002: SCORING OF RE-RIDE

When a re-ride is taken, the re-ride shall be scored and the pass for which the re-ride was given shall be annulled.

1003: OPTIONAL RE-RIDE

- (A) **Conditions or Malfunctions.** The skier shall be offered an optional re-ride only on the pass affected when water, weather or other conditions are substantially different from their competitor's conditions or in the event of a malfunction of the tournament-supplied equipment occurs that, in the opinion of the majority of the Event Judges, unfairly affects a skier.

- (B) **Skier Instructions.** The skier shall be offered an optional re-ride, only on the pass affected, when the towboat crew failed to comply with the skier instructions given and speed tolerances in accordance with Chapter 3.

- (C) **Engine Trim Position.** Skier shall be offered an optional re-ride only on the pass affected if the engine trim position was not at the default position prior to the pass as required by 1501(B).

- (D) **Towboat Path During the Jump Event.** Skier shall be offered an optional re-ride only on the pass affected if the path of the towboat differs by more than one-half of the gate width from that requested by the skier.

- (E) **Towboat Path During the Slalom Event.** During the pass the towboat shall follow a straight path, approximately down the center of the course until either the shut-down buoy is reached, the skier loses possession of the handle, or the 15 seconds expires, whichever is first.

- (F) **Towboat Path During the Trick Event.** During the pass the towboat shall follow a straight path, approximately down the center of the course until either the shut-down buoy is reached, the skier loses possession of the handle, or the 15 seconds expires, whichever is first.

- (G) **Malfunction.** Should a malfunction of the jump measuring equipment render an otherwise valid jump to be unreadable, the skier shall be offered an optional re-ride or the lowest distance readable on the screen, minus one-tenth meter [408(E)].

1004: MANDATORY RE-RIDE

- (A) **Unfair Advantage.** Skier shall have a mandatory re-ride when it's the opinion of the majority of the Event Judges that a malfunction or conditions gave the skier an unfair advantage on the pass affected.

- (B) **Start/End of Pass.** Skier shall have a mandatory re-ride if the start or end of the pass cannot be determined by the combined use of the official video and the Event Judges' sheets on the pass affected.
- (C) **Jump Event.** Skier shall have a mandatory re-ride if the speed through the jump course is judged to have exceeded the maximum course speed of 73.5 kph/45.7 mph as checked by a GPS speed-measuring device **while the skier is in possession of the handle and prior to BSP being recognized after the jump [405(D)].**
- (2) **Repeat Start and Trick Pass.** The entire pass for which the re-ride is given shall be annulled and scoring for the re-ride shall comprise the start trick and the pass tricks made in the 15 seconds of the re-ride pass.
- (B) **Pass Trick.** In the event of a re-ride during the pass tricks portion of the pass:
- (1) **Annulled Pass.** The 15-second pass score of the affected pass shall be annulled.
- (2) **Start Trick.** Any start trick on the affected pass, whether successful or unsuccessful, shall stand and be carried forward as the start trick score for the re-ride of that pass. On the re-ride, the skier is permitted to attain BSP by any start trick listed in 604 that he chooses, but that start shall not count for scoring purposes.
- (3) **Scoring.** Scoring for the re-ride shall comprise pass tricks made in the 15 seconds of the re-ride pass plus the start trick score carried forward from the affected pass.

1005: RE-RIDES—WHEN TAKEN

- (A) **Jump Event.** Re-ride shall be taken:
- (1) **Immediately.** If a single re-ride is granted for other than temporary incapacitation, that re-ride shall be taken immediately.
- (2) **Five-Minute Rest.** If more than one re-ride is taken in any series, the skier shall have the option of a five-minute rest before recommencing his turn in accordance with 1205 (A).
- (B) **Slalom and Trick Event.** If a re-ride is granted for other than temporary incapacitation, that re-ride shall be taken either immediately or the skier may elect a five minute rest period permitted in accordance with 1205(B). If the skier has elected the option of a 5-minute rest period the next skier in order shall ski, and the re-ride shall be taken at the conclusion of the skier's turn during which the 5-minute rest period expires.

Note: See 1206 if skier becomes temporarily incapacitated.

1006: RE-RIDE OPTIONS—TRICK

- (A) **Start Trick.** In the event of a re-ride during the start trick portion of the pass, the skier shall have the option of:
- (1) **Repeat Start Trick Only.** Repeating the start trick while retaining the pass tricks scored during the affected pass, or:
- (2) **Repeat Start and Trick Pass.** The entire pass for which the re-ride is given shall be annulled and scoring for the re-ride shall comprise the start trick and the pass tricks made in the 15 seconds of the re-ride pass.
- (B) **Pass Trick.** In the event of a re-ride during the pass tricks portion of the pass:
- (1) **Annulled Pass.** The 15-second pass score of the affected pass shall be annulled.
- (2) **Start Trick.** Any start trick on the affected pass, whether successful or unsuccessful, shall stand and be carried forward as the start trick score for the re-ride of that pass. On the re-ride, the skier is permitted to attain BSP by any start trick listed in 604 that he chooses, but that start shall not count for scoring purposes.
- (3) **Scoring.** Scoring for the re-ride shall comprise pass tricks made in the 15 seconds of the re-ride pass plus the start trick score carried forward from the affected pass.
- (A) **Top Speed Advisory.** Any top speed advisories given from the towboat during the competition shall be considered a courtesy and shall never be grounds for a re-ride or protest.
- (B) **Standard Terminology.** When preparing to start from rest, the skier shall communicate with the towboat only with the words "IN GEAR," "OK," or "STOP." The towboat shall only proceed on the "OK" command. A misunderstanding due to a departure from this standard terminology shall never be grounds for a re-ride or protest.
- (C) **Before Turn-Around Time.** A skier going before the turn-around time has expired [1201(C)] shall never be grounds for a re-ride or protest.
- (D) **Rope Position.** Incorrect rope attachment height [302(A) & 303(A)] shall never be grounds for a re-ride or protest.
- (E) **Boat Speed.** The failure of the towboat to attain a speed greater than 72 kph/44.7 mph shall never be grounds for a re-ride or protest.
- (F) **Last Trick In Time.** A mistake by the Event Judges communicating the last trick in time [714(D)] shall never be grounds for a re-ride or protest.

(G) Provisional Score. An error or misunderstanding on the part of the Officials in communicating provisional scores [1010] shall never be grounds for a re-ride or protest.

(H) Skier Lands Prior to or Past Landing Box. A successful jump that is unreadable due to the skier landing prior to or past the video box shall never be grounds for a re-ride or protest.

(I) Failure of Skier's Equipment. A failure of skier's own equipment shall never be grounds for a re-ride or protest.

Note: See 1202(B) for one-minute equipment provision.

(J) Skier's Equipment. Failure of a skier in the trick event to ensure their equipment is in the towboat for the second pass shall never be grounds for a re-ride.

(K) 30-Second Call. Failure of the event judges to give the 30-second call shall never be grounds for a re-ride.

(L) Engine Trim Position. If the skier requests the engine position to be changed, this shall never be grounds for a re-ride or protest.

Note: See 1003(C) for optional re-ride if the engine position was not at the default position [1501(B)] prior to the pass.

1008: START AND PASS INSTRUCTIONS

In the case of a re-ride, the skier's instructions for the start and/or pass may be different from those given for the annulled pass.

1009: REFUSAL TO ENTER COURSE

A competitor is permitted, for reasons acceptable to the Event Judges, to refuse to enter the course in any event and shall do so by throwing the handle into the air.

Note: Re-rides are only given in accordance with the conditions specified in 1003.

1010: PROVISIONAL SCORE

In the event of an optional re-ride being offered, the skier has the option of requesting a provisional score from the Event Judges before deciding to accept or decline the re-ride. This provisional score need not be communicated as total points, but may be communicated as tricks/crossings that were and were not credited or the provisional jump distance communicated from the Video Judges.

CHAPTER 11: SAFETY

1101: SAFETY DIRECTOR

- (A) **Responsibility.** The Safety Director shall be responsible for monitoring the safe condition of all equipment and facilities and the operation of the tournament, but this shall not prevent him from delegating specific responsibilities to assistants as approved by the Chief Judge.
- (B) **Proximity.** The Safety Director shall remain near the competition area as much as possible.
- (C) **Authority.** The Safety Director shall have the authority to take whatever action is necessary, including stopping the tournament, whenever he observes a condition he believes unsafe.
- (D) **Halt Tournament.** During the competition, the Safety Director is permitted to request the Chief Judge to halt the tournament for a poll of the Event Judges in regard to a skier's actions or condition.
- (E) **Overruled by Chief Judge.** The Chief Judge is authorized to overrule any contemplated action or decision of the Safety Director, but on his own responsibility.

Note: See PPG for WBC Safety Manual.

1102: FLOTATION AND PROTECTION

- (A) **Flotation.** A neoprene wetsuit or dry suit meeting the following requirements shall be worn by all skiers in all events:
 - (1) Be smooth, soft, and free from attachments or material likely to cause injury in a fall.
 - (2) Be so constructed and fastened that it's unlikely to be torn loose or damaged so as to render it useless in a hard fall.
 - (3) Float the user.
 - (4) Not be an inflatable device.
 - (5) Be constructed so as to provide adequate protection from impact damage to the ribs and internal organs.

- (B) **Suitability.** In case of doubt on the suitability of flotation, the Safety Director shall order a practical test in the water.

1103: HELMETS

- (A) **Specification.** A skier in the Jump Event shall wear a helmet of a type designed to protect the head from severe impact injury.
- (B) **Skier Loses Helmet.** If a skier loses his helmet during the start or before reaching the jump ramp, the towboat shall immediately stop, unless it's unsafe to do so. Should it be unsafe for the towboat to stop, the skier shall ski past the jump whenever possible, and this jump shall be scored as a fall. These are not grounds for disqualification from the remainder of the event.

Note: The skier is permitted to return to the starting dock to obtain replacement equipment in accordance with the 1202.

- (C) **Radio Communications.** The use of helmets fitted with radio communication capabilities is prohibited in the Jump Event.

1104: SAFETY OFFICER

- (A) **Safety Officer.** A Safety officer who is familiar with all tournament events and practice and ideally is fully trained in First Aid, Emergency Resuscitation and Water Rescue Techniques shall be on-site at all times.
- (B) **Floated to Shore.** Any skier that is unable to climb into a towboat unassisted shall be floated ashore and lifted from the water on a suitable board or stretcher.
- (C) **Into Towboat.** Under no circumstances will an injured skier be lifted passively over the side of a towboat.
- (D) **Life Jacket.** A life jacket shall be in the towboat at all times; in the event of a serious fall by the skier, a swimmer wearing a life jacket shall enter the water to assist the skier.

(E) Safety Swimmer. During the jump event a swimmer trained in water rescue, wearing flotation, having a backboard/flotation stretcher shall be present at the jump area.

1105: DISQUALIFICATION

(A) Safety Compliance. Failure of a skier to wear a wet suit or helmet when required shall be cause of immediate disqualification from the event by the Safety Director [210(A)].

(B) Danger to Himself. No skier shall be allowed to compete or continue to compete if, in the opinion of the Chief Judge, Safety Director and a majority of the Event Judges, his competing would be a danger to himself or to other skiers in the tournament. Whenever practical the advice of a doctor shall be obtained [210(B)].

CHAPTER 12: TIMING RULES

1201: TURN-AROUND TIMES

- (A) **Set by Chief Judge.** The Chief Judge will set the turn-around time after considering the recommendation of the Tournament Director and Chief Driver.
- (B) **Responsibility of Driver.** Turn-around times between passes is the responsibility of the Driver as follows:
- (1) **Time Commences.** The time clock starts on whichever is later; the towboat or chase towboat coming off plane at the end of the course.
 - (2) **Warning.** The driver shall notify the Event Judges at 30 seconds and 10 seconds to the expiration of the turn-around time. Event Judges shall notify the skier at 30 second and 10-second to expiration of turn-around time.
- (C) **Skier Option.** Except in jump, the skier has the option to go before the turn-around time has expired.

1202: EQUIPMENT FAILURE, ONE-MINUTE

- (A) **First Pass.** If the majority of the Event Judges agree they shall grant up to 1 minute for gear changes to replace broken or damaged equipment developing or discovered just prior to the skier's pass.
- (B) **Second Pass.** If the majority of the event judges agree, they shall grant up to 1 minute for gear changes or repair. The skier is permitted to return to the starting dock in the towboat to use the equipment minute to obtain replacement equipment in accordance with the following:
- (1) The skier is not permitted to retrieve equipment forgotten on the starting dock or other location.
 - (2) The equipment minute shall start when the towboat is safely positioned at the starting dock. If at the expiration of the equipment minute the skier is not ready to enter the towboat from the starting dock, the skier shall forfeit his second pass.

1203: EMERGENCY, ONE-MINUTE

If at the expiration of the equipment minute [1202] the skier is not ready to start the pass, the skier shall be disqualified for "failure to go" in accordance with 210(F). The disqualification of a skier for "failure to go" shall be treated as an emergency for next skier and he shall be granted one emergency minute to prepare to ski. An additional emergency minute shall be granted for each skier in turn that is disqualified.

1204: INJURY RECOVERY, THREE-MINUTES

At the discretion of the Event Judges, the skier can be granted three minutes to recover from a heavy fall between passes, starting at the time of the decision to grant the recovery time. If the skier cannot recover from a heavy fall within those three minutes, he shall not be permitted to ski again in that round.

1205: RE-RIDE, FIVE-MINUTE REST

- (A) **Jump Event.** If more than one re-ride is taken in any jump series, the skier shall have the option of a five-minute rest before recommencing his turn in accordance with 1005(A).
- (B) **Slalom and Trick Event.** The skier has the option of a five-minute rest period in accordance with 1005(B).

1206: TEMPORARY INCAPACITATION RECOVERY TIME

If the skier should become temporarily incapacitated through no fault or action of his own, the skier shall be allowed time to recover until next round of competition of that event has started or it can be satisfied, where possible on medical advice, that he is sufficiently recovered to continue. In the meantime, the competition goes on with succeeding skiers.

CHAPTER 13: VIDEO AND RADIOS

1301: ASSIGNMENT

The video camera shall be operated by a Video Operator or be affixed to a solid mounting device in the towboat.

1302: MEDIA

The Chief Judge is permitted to allow an additional accredited camera operator to ride in the towboat for the purposes of the media

1303: OFFICIAL USE

(A) When Permitted. The Event Judges are only permitted to view the official video of an event before the expiry of the protest time at the request of the Chief Judge or Chief Scorer, under the following circumstances:

- (1) **Simple Majority.** To obtain a majority decision as to the skier's performance.

- (2) **Failure of Timing Device.** To determine the time parameters of a pass in the event of failure of the timing device.

- (3) **Exceptional Circumstances.** In circumstances which are judged to be exceptional, the Chief Judge or Chief Scorer is authorized to instruct the Event Judges to review the video recording to correct errors or misconceptions

- (B) Jump Event.** Event Judges are permitted to review the official video immediately so as to ascertain the validity of the jump before the next jump is taken.

Note: See PPG for specific video review procedures.

1304: COMMUNICATIONS

Efficient two-way radios shall be provided for the Chief Judge, Assistant Chief Judge, Chief Scorer, Safety Director, Tournament Director, towboat, and jump computer station.

Wake Crest (Lift-Off Point) - Curled Shoulder

102

Wake Crest
(Lift Off Point)

Wake Crest
(Lift Off Point)

Wake



The wave curl is the point of the wave crest (lift-off point).

Wake Crest (Lift-Off Point) - Smooth Shoulder

102

Wave Crest
(Lift Off Point)

Wave Crest
(Lift Off Point)

Wake

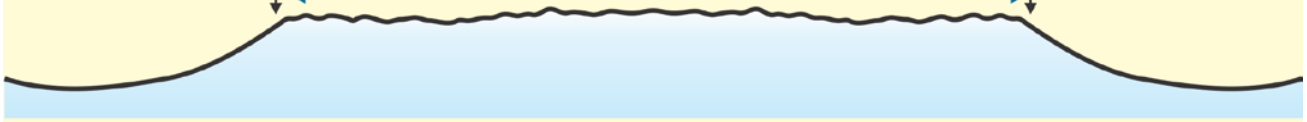

The point where the wave shoulder begins the downturn to the outside of the wake.

Slalom Points - Two-Foot Crossing 504(D)(1)

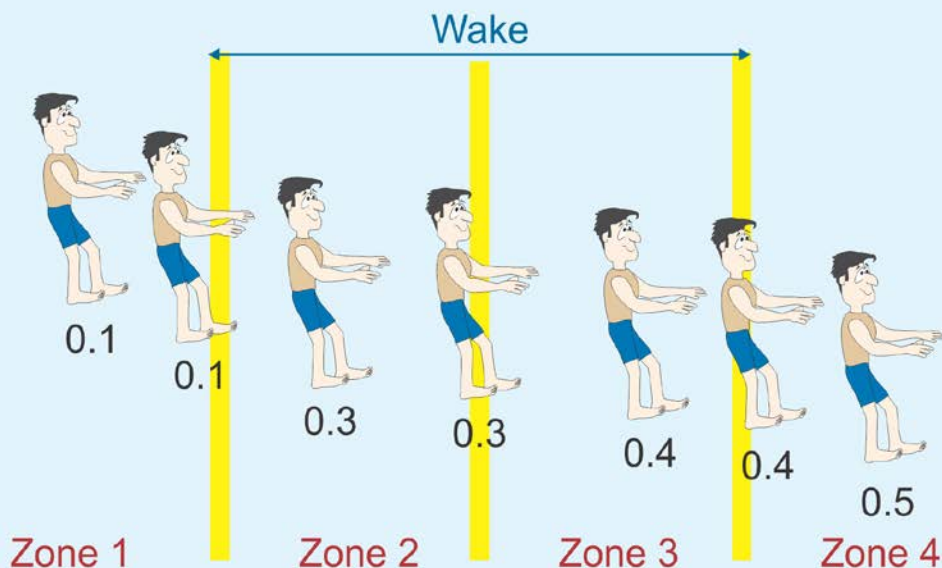

Slalom Points - One-Foot Crossing 504(D)(2)

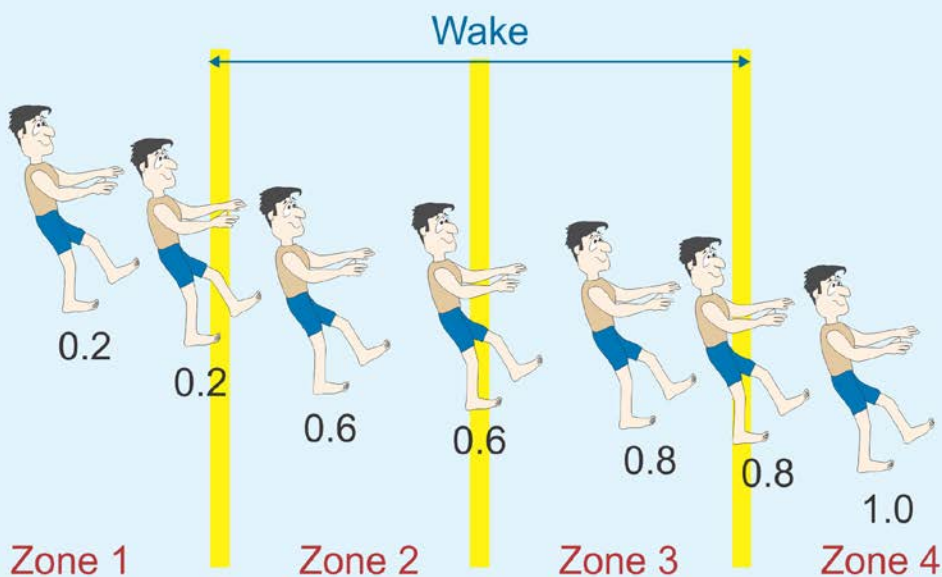

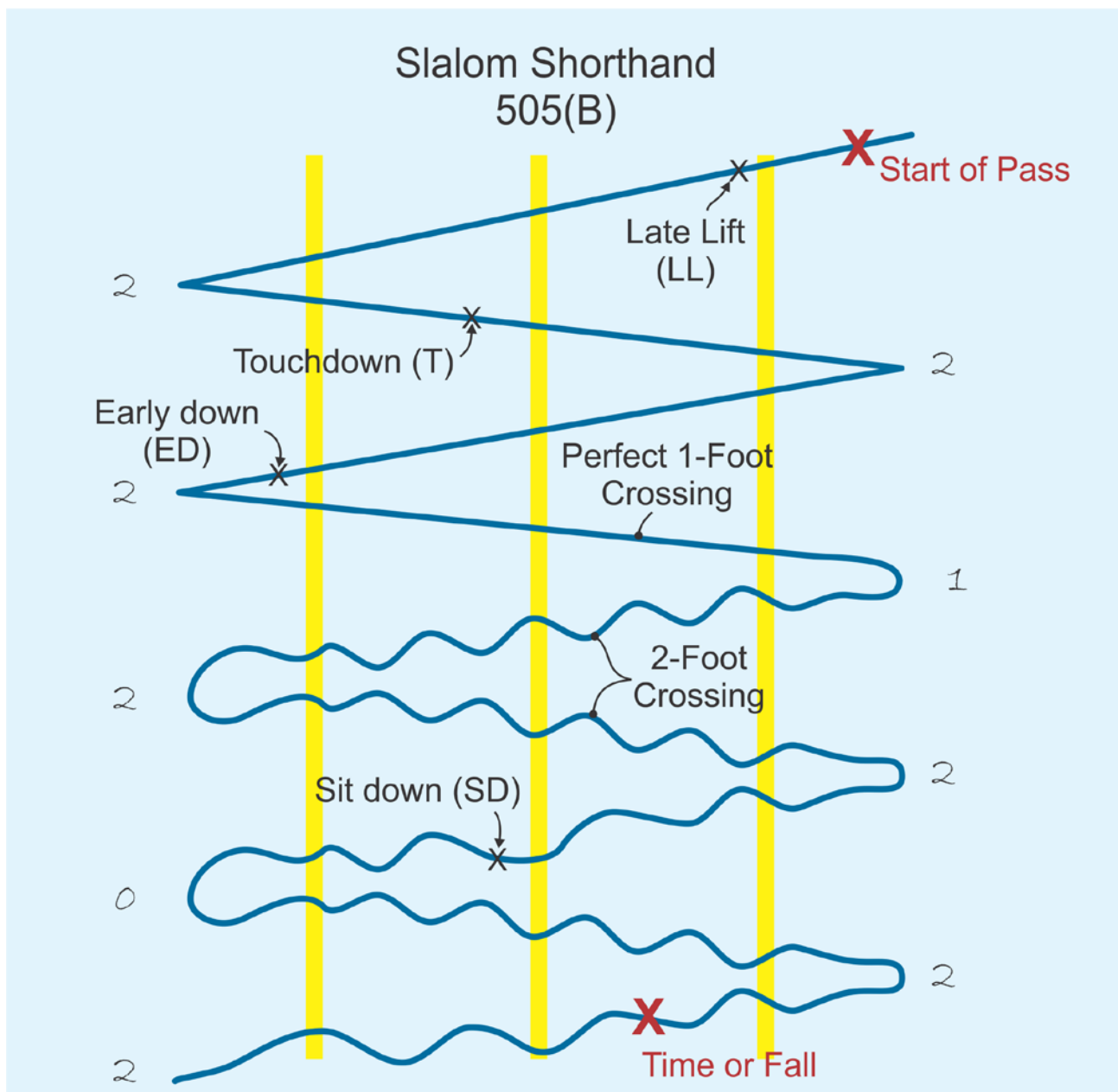

Start Points - 602				
	Two Feet	One Foot	Flyer Bonus	Tower Bonus
Front Deep	50	100	50	150
Front Toe-Up		400		
Front Tumble	100	150	50	100
Back Deep	200	500	100	200
Back Toe-Up		450		
Back Tumble	400	700	100	200

	Trick Point Values - 712(A)				
	Surface Tricks		Wake Tricks		Wake-to Wake
	Two Foot	One Foot	Two Foot	One Foot	
General					
Hop Backward	100*		150§		250§
Hop Forward	20*		30§		100§
Knee Skiing	30		*Bonus Trick - 713(A) Hop Forward 1 Foot 50 Hop Backward 1 Foot 100 Hop Back 2 Foot Line 100 Hop Back 1 Foot Line 200 One-Foot Back Line 100 § One only i.e. no reverse		
One Foot Backward		100*			
One Foot Forward		30			
Rope in Teeth	20	50			
Rope on Neck	20	50			
Side Slide - Backward	450§				
Side Slide - Forward	150§				
Side Slide Switch	600§				
Sit Down/Stand Up	20	40			
Somersault (Flip)	500				
Toe Hold Backward		150			
Toe Hold Forward		100			
Tumble 180	50	100			
Tumble 360	50	100			
Wave	10				
Turns - Surface					
180 Back-to-Front	200	350	300	500	500
180 Front-to-Back	250	350	400	500	600
360 Back-to-Back	550	1050	700	1200	900
360 Front-to-Front	450	950	600	1100	800
540 Back-to-Front	750	1350			
540 Front-to-Back	850	1450			
720 Back-to-Back	1050	1850			
720 Front-to-Front	950	1750			
Turns - Step-Over					
Step-Over 180 Back-to-Front	350		500		
Step-Over 180 Front-to-Back	450				
Step-Over 360 Back-to-Back	950				
Step-Over 360 Front-to-Front	850				
Step-Over 540 Back-to-Front	1250				
Step-Over 540 Front-to-Back	1350				
Step-Over 720 Back-to-Back	1850				
Step-Over 720 Front-to-Front	1750				
Turns - Rope-on-Foot					
Toe Back-to-Front		850		1500	
Toe Back-to-Front Toe Start Recovery		300			
Toe Front-to-Back		350		700	

Tricks Shorthand Table - 714(B)

	Surface Tricks				Wake Tricks				Wake-to Wake
	Two Foot		One Foot		Two Foot		One Foot		
	Basic	Rev	Basic	Rev	Basic	Rev	Basic	Rev	
General									
Hop	Λ		Λ>	<Λ	Λ _v				Λ _w
Knee Skiing	K								
One Foot			>	<					
Rope in Teeth	T		T>	<T					
Rope on Neck	N		N>	<N					
Side Slide-Backward	BSS								
Side Slide-Forward	SS								
Side Slide Switch	SSS								
Sit Down Stand Up	SD		SD>	<SD					
Somersault (Flip)	O				O _v				O _w
Toe Hold			C.	.C					
Tumble 180	↵	↵	↵>	<↵					
Tumble 360	↻	↻	↻>	<↻					
Wave	W.	.W							
Turns									
180° Turn	1.	.1	1>	<1	1 _v	v1	1> _v	v<1	1 _w
360° Turn	3.	.3	3>	<3	3 _v	v3	3> _v	v<3	3 _w
540° Turn	5.	.5	5>	<5					
720° Turn	7.	.7	7>	<7					
Step Turn 180°	S1	1S			S _v	vS			
Step Turn 360°	S3	3S							
Step Turn 540°	S5	5S							
Step Turn 720°	S7	7S							
Toe Back-to-Front Ft-to-Ft			C ₁	1C			C _v	vC	
Toe Back-Front Toe Start Rec			C ₂	2C					
Toe Front-to-Back Ft-to-Ft			C ₁	1C			C _v	vC	

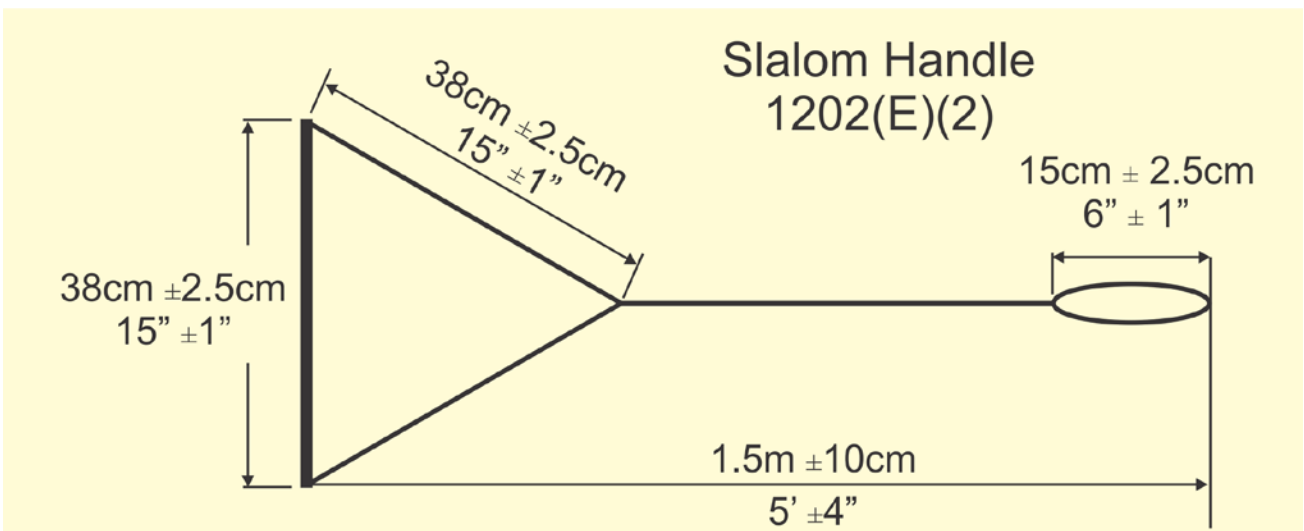
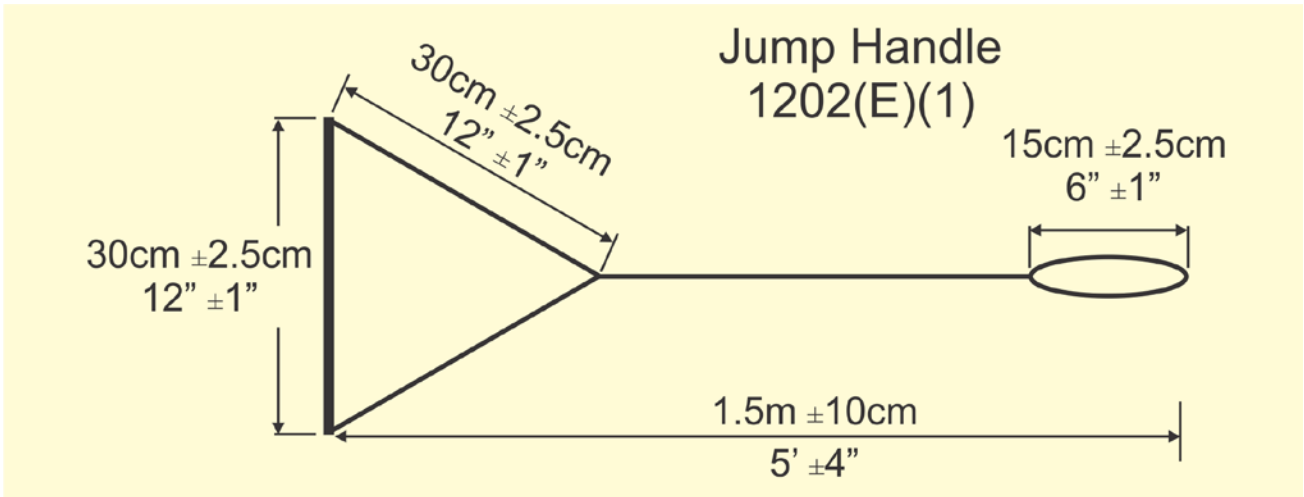

Tournament Supplied
Rope and Handle Length
1203(B)(3)

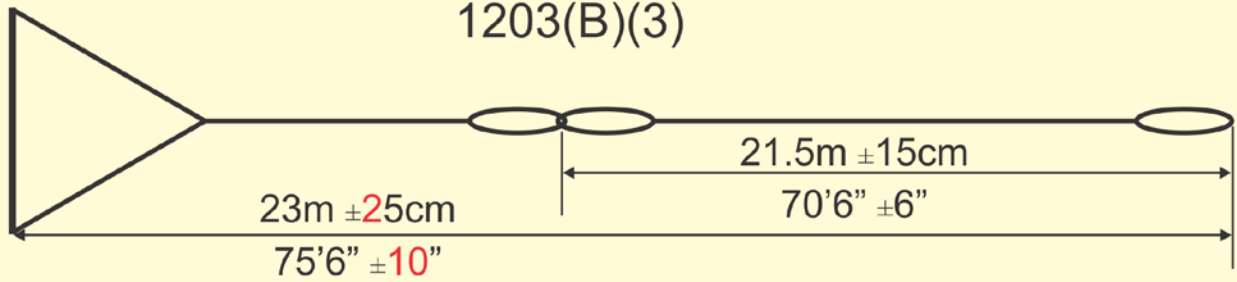

PART I TECHNICAL REQUIREMENTS INDEX

	Section	Page		Section	Page
General Rules					
Abbreviations	101	2	Re-Ride Options—Trick	1006	32
Amendments to the Rules	206	4	Re-Ride Request	1001	31
Convention	202	4	Re-Rides—When Taken	1005	32
Definitions	102	2	Scoring of Re-Ride	1002	31
Disqualification	210	5	Start and Pass Instructions	1008	33
Event Judges	213	6	Safety		
Exceptions to the Rules	203	4	Disqualification	1105	35
Interpretation of the Rules	204	4	Flotation and Protection	1102	34
Interruptions and Stoppage	209	5	Helmets	1103	34
Introduction	201	4	Safety Director	1101	34
New Tricks	208	5	Safety Officer	1104	34
Replacing Officials	212	5	Skier Instructions		
Results Posting	211	5	Commands	301	7
Rule Change Procedure	207	4	Jump Event	302	7
Rules Revision	205	4	Slalom and Trick Event	303	7
WBC Ranking List	214	6	Slalom Event		
Jump Event			Credit	504	12
Credit for Jump	404	9	End of Pass	503	12
Disallowed Jump	405	9	Officials	506	14
Distance	408	10	Passes	501	11
Jump Measurement and Calculation	407	10	Scoring	505	13
Officials	409	10	Start of Recording	502	11
Passes—Jumps	403	9	Starts		
Scoring	406	9	Dock, Tower, or Dry-Land Start (Flyer)	603	15
Start	401	9	General	601	15
Start of Pass—Jump Attempt	402	9	Scoring	602	15
Protests			Start Trick Descriptions	604	16
Calculation Error	905	29	Trick Descriptions		
Chief Judge Decision	903	29	180 Back-to-Front	804	25
Protest Basis	901	29	180 Front-to-Back	805	25
Protest Procedure	902	29	360 Back-to-Back	807	26
Reverse Chief Judge Decision	904	29	360 Front-to-Front	806	25
Re-Rides			540 Turns	808	26
Mandatory Re-Ride	1004	31	720 Turns	809	26
Not Basis for a Re-Ride	1007	32	General Pass Tricks	801	22
Optional Re-Ride	1003	31	Rope-on-Foot Turn Feet-to-Feet	811	27
Provisional Score	1010	33			
Refusal to Enter Course	1009	33			

PART I TECHNICAL REQUIREMENTS INDEX

(continued)

	Section	Page		Section	Page
Rope-on-Foot Turn Toe-Start Recovery	812	27			
Rotation Rule for Surface-Turns	803	24			
Somersault	813	28			
Step-Over Turn	810	26			
Turn Tricks General	802	24			
Tricks—General Requirements					
Bonus Actions	713	20			
Credit for Tricks	704	18			
Downgrades	715	21			
End of Scoring	703	18			
Loss of BSP	706	18			
Officials	714	20			
One Attempt for Credit	716	21			
Passes	701	18			
Precursory Tricks	711	19			
Repeating Failed Tricks	707	19			
Reverse Tricks	709	19			
Scoring—Trick Point Values	712	19			
Simultaneous Tricks	710	19			
Skier Responsibility	705	18			
Start of Time and Recording	702	18			
Trick After Expiration of Time	708	19			
			Timing Rules		
			Emergency, One-Minute	1203	36
			Equipment Failure, One-Minute	1202	36
			Injury Recovery, Three-Minutes	1204	36
			Re-Ride, Five-Minute Rest	1205	36
			Temporary Incapacitation		
			Recovery Time	1206	36
			Turn-Around Times	1201	36
			Video and Radios		
			Assignment	1301	37
			Communications	1304	37
			Media	1302	37
			Official Use	1303	37

Part II:

HOMOLOGATION REQUIREMENTS

CHAPTER 14: Handles, Ropes, and Timers	49
CHAPTER 15: Towboats	51
CHAPTER 16: Course Requirements	52
CHAPTER 17: World Records	54

CHAPTER 14: HANDLES, ROPES, AND TIMERS

1401: GENERAL

There shall be sufficient quantities of tournament-supplied homologated ropes and handles on-site prior to the start of the tournament so as to ensure for the smooth operation of the tournament.

1402: HANDLES

Tournament-supplied handles shall meet the following requirements:

(A) **Flotation.** Handles shall float or incorporate flotation.

(B) **Grip.** The handle grip shall be made of 25mm to 28mm outside diameter material with no sharp edges or projections, and with non-slip coating. Attaching ropes shall in all cases go through the handle grip and shall be attached so there is no possibility of movement between the rope and handle grip when in use.

(C) **Loop.** Handles shall be finished with minimum 15cm loop.

(D) **Length.** The handle and bridle shall have a length of 1.50m \pm 10cm

(E) **Width.**

(1) **Jump Event.** A handle having a width of 30cm \pm 2.5cm, with a 30cm \pm 2.5cm length of attached ropes before juncture shall be in the towboat and be the only handle used in the Jump Event.

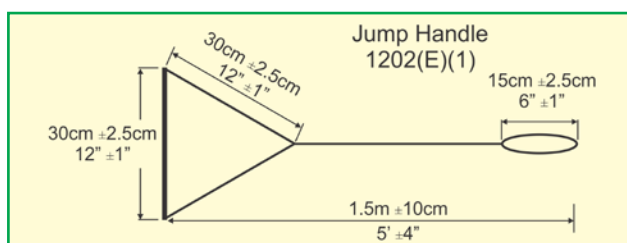

(2) **Slalom and Trick Event.** A handle having a width of 38cm \pm 2.5cm, with a 38cm \pm 2.5cm length of attached ropes before juncture and a handle having a width of 30cm \pm 2.5cm, with a 30cm \pm 2.5cm length of attached ropes before juncture shall be in the towboat.

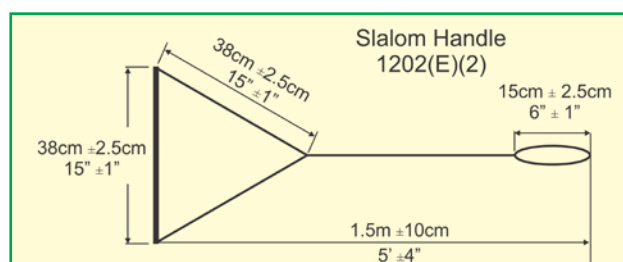

1403: ROPES

For the purposes of this rule a rope and leader combination shall be considered the rope. The Tournament Committee shall have at least one rope meeting the following requirements in the towboat for all events:

(A) **Stretch.** Ropes shall be made from a low-stretch plastic or similar material and have been sufficiently pre-stretched so as to allow only minimal stretch.

(B) **Length.**

(1) **Rope.** The overall length of the tournament-supplied rope shall be 21.5m \pm 15 cm.

(2) **Leader.** A leader of 2m \pm 15cm shall be attached to the middle attachment point [1501(D)(2)] and optional high attachment point [1501(D)(3)] and shall be equipped with a light weight fitting [1403(D)] for the attachment of ropes during the trick and slalom events.

(3) **Rope and Handle.** The tournament-supplied rope length with the handle shall be 23m \pm 25cm

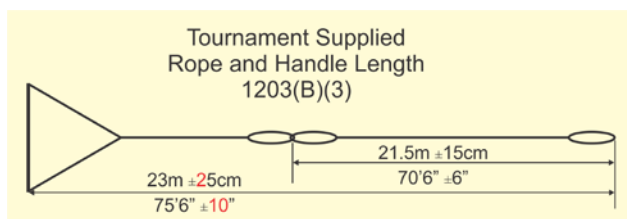

- (C) **Loops.** Loops shall be a minimum 15cm at the attachment end of the rope and a minimum of 40cm at the handle end of the rope.
- (D) **Rope Fittings.**
- (1) A lightweight fitting approved by the Chief Judge for easy attachment of leaders, ropes, or handles shall be permitted for any event.
 - (2) Metal clips shall not be used in the jump event.
- (E) **Junctures.** Junctures in lines shall be by splicing or threading of adequate length to prevent slippage, and reinforced where necessary by knotting, stitching or binding.
- (F) **Measurement.** Measurements of ropes and handles shall be made with 20 kg (44 lb) of tension and shall be between the center of the handle grip (or inside of rope loop) and the inside of the rope loop at the other end.

1404: SKIER SUPPLIED ROPE AND HANDLE

- (A) **Rope and Handle.** For the Trick Event, the skier is permitted to furnish his own rope and handle of any size, length and material.

- (B) **Rope.** Loops shall be a minimum 15cm at the attachment end of the rope. Tying the rope to the attachment point is not permitted.
- (C) **Handle.** Detachable handles shall be finished with a 40cm loop or lightweight fitting for easy attachment of handle.

1405: AUDIBLE TIMING DEVICE

For timing the 15-second period in the Slalom and Trick events, an automatic timing device giving an audible sound at the start and finish of pass shall be used by one of the following means:

- (A) **Majority Timer.** A timing device that provides three operating switches, one for each of the three Event Judges, shall operate as follows:
- (1) **Each Judge.** Each Event Judge shall operate his switch when he observes the start of pass as defined in 502 for Slalom and 702 for Tricks.
 - (2) **Two of Three Event Judges.** The timing device shall be programmed to sound the signal and start the 15-second timing at the moment when two of the three Event Judges have operated their starting switches. Thus, the first switch to be pressed in chronological order shall arm the device and thereafter the second to be pressed will activate it.
- (B) **Instantaneous Timer.** A timing device with a single operating switch shall be permitted. One of the Event Judges shall be assigned to operate the timer switch when he observes the start of pass.

CHAPTER 15: TOWBOATS

1501: BOAT SPECIFICATIONS

(A) Speed Guarantee. Towboats containing the required boat officials as per 212 shall have the performance necessary to obtain 72 kph/44.7 mph by the entry gate for the Jump Event and skier's advisory buoy for the Trick and Slalom Event, while towing a barefoot skier weighing approximately 80k/175 lb.

- (1) Lengthen Course Run-Up.** If necessary, the length of the run-up shall be adjusted, subject to the limits contained in 1602(A), to make the attainment of the required speed by the skier's advisory buoy possible.
- (2) Full Throttle Acceptable.** In complying with this speed requirement, it's understood that full throttle may be used throughout the acceleration phase.

(B) Engine Trim Position. Where trimming capability is fitted to the towboat, the Homologator shall set the trim to achieve the required speed and optimum wake. This position shall be the default position for the tournament. It is the responsibility of the Driver to ensure the engine is at the default position before every skier.

(C) Size. Overall length shall be approximately 5m, but shall not exceed 7m and the beam shall be not less than 1.80m and not more than 2.50m.

(D) Points of Attachment. Towboats shall be equipped with towing attachment points on the center-line of the towboat with the following heights above the water when the towboat is standing still with no occupants on board.

- (1) Mandatory Lower Attachment Point.** Minimum of 65 cm and a maximum of 1.2m.
- (2) Mandatory Middle Attachment Point.** Minimum of 1.8m and the maximum of 2.25m
- (3) Optional High Attachment Point.** Approximately 4.0m

(E) Speed-Measuring Devices. Towboats shall contain three speed-measuring devices:

- (1)** At least one speed measuring device shall be a GPS.
- (2)** Two shall be visible to the Driver.
- (3)** One shall be visible to **at least one** Event Judge when facing aft.

(F) Tachometers. Towboats shall be equipped with one tachometer.

Note: The failure of the towboat to attain a speed greater than 72 kph/44.7 mph is not grounds for a re-ride or protest [1007(E)].

1502: TOP SPEED ADVISORY

Before the start of the tournament the Chief Driver shall inform the Chief Judge of the top speed attained at the skier's advisory buoy for all towboats as per the conditions in 1501A and 1501B. This information shall be supplied to the competitors or team representatives before the start of the tournament.

1503: SPEED CHECK

(A) Boat Speed Check. Before each event and/or at the discretion of the Chief Judge, the towboat speed-measuring device shall be checked with a GPS speed-measurement device to obtain the correct boat speed under tournament conditions.

(B) Current or Stream. If there is a current or stream, **the speed of that current must be added to the speed displayed in the GPS when traveling with the current and subtracted from the speed displayed by the GPS when traveling against the current.**

1504: SPEED CONTROL

Speed control systems approved by the Chief Judge shall be used when available and speeds ascertained from these devices shall be used as the primary means of determining the towboat speed through the course.

CHAPTER 16: COURSE REQUIREMENTS

1601: JUMP COURSE

The Jump course dimensions shall be in accordance with the following:

- (A) **Jump Ramp.** The jump ramp shall be set parallel to the jump course. The method of determining this requirement can be either via a surveyed course, a measured course, or visual line of sight.
- (B) **Buoys.** No buoys or markers other than those required by 1602(A) are permitted within the jump course area except to mark safety hazards. Any such buoys shall be distinguishable from course buoys and shall be pointed out to team representatives/skiers before the start of the competition.
- (C) **Departure Point.** The departure point for the Jump Event shall be not less than 200m before the jump course entrance gate and shall be as close as possible to an extension of the course line.

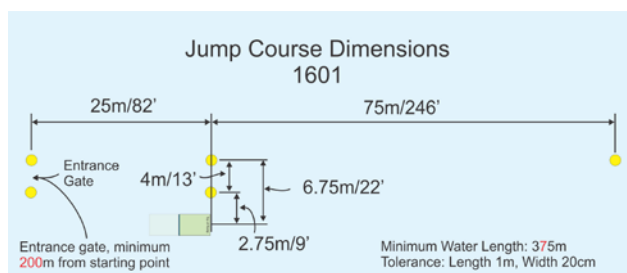

1602: SLALOM AND TRICK COURSE

- (A) **Course Dimensions.** The dimensions of the courses shall be as indicated in Figure 1602; however, the layout of the competition area is permitted to be varied to suit the tournament site. The competition site shall encompass a starting dock, skier advisory buoys, shutdown buoys and a turn-around buoy at the far end.

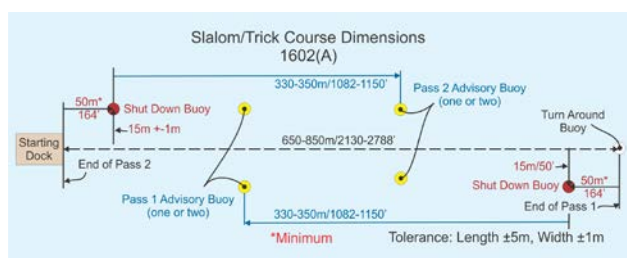

- (1) **Dock.** The starting dock shall be as near the extension of the course line as possible and shall be of a size to allow the skier to take more than one hop, skip or step on the dock before a dock start.
- (2) **Optional Tower.**
 - (a) Provision of a tower is optional at LOC discretion, and where provided it shall be between 2.5m and 5m above the water surface.
 - (b) The optional tower shall be as near the extension of the course line as possible and shall be of a size to allow the skier to take more than one hop, skip or step on the tower before a tower start.
- (3) **Course Line.** The course lines for the two passes should coincide if possible. If necessary for spectator viewing, the courses are permitted to be angled to or distanced from each other.
- (4) **Turn-Around Buoy.** The distance between the starting dock and the turn-around buoy shall be not less than 650m and not more than 850m. The turn-around buoy shall be on the extended course line.
- (5) **Skier Advisory Buoys.** For both passes, a skier's advisory buoy(s) shall be located between 330m and 350m from the shutdown buoy, approximately 15m perpendicular from the course line on each side of the course.
- (6) **Shutdown Buoy.** The shutdown buoy shall be located on the Driver's side approximately 15m from the course line a minimum of 50m from the end of course or turn-around buoy and shall be of a contrasting color to the skier advisory buoys.

The shutdown buoy marks the point at which the Driver shall smoothly close the throttle in order to safely stop the towboat before the end of the course.

- (B) **Buoys.** No buoys or markers other than those required are permitted within the competition area, except to mark safety hazards, landing or starting areas, or turning buoys. Any such buoys shall be distinguishable from course buoys and shall be pointed out to team representatives/skiers before the start of the competition.

1603: JUMP RAMP

The jump ramp shall meet the following specifications:

- (A) **Height.** The height of the lip of the jump ramp shall be $45.5\text{cm} \pm 1.0\text{cm}$ above the waterline, measured on both sides.

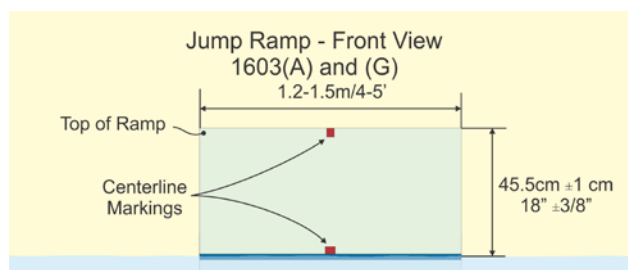

- (B) **Surface.** The surface of the ramp out of the water shall be $210\text{cm} \pm 4.2\text{cm}$ long, with the waterline marked by the center of a transverse line of contrasting color of a width equal to the total 8.4cm . The width of the ramp surface shall be a minimum of 1.20m and a maximum of 1.50m with parallel sides. The surface of the jump ramp shall be flat with a maximum deviation of $\pm 1\text{cm}$ from a plane. The overall length of the ramp surface shall be a minimum of 3.6m .

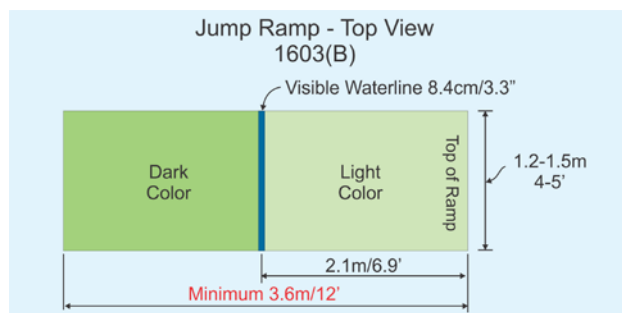
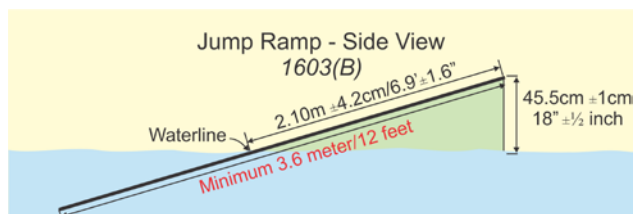

- (C) **Transverse Line Marking.** The centerline of the transverse line shall be marked at least at the edges of the ramp.
- (D) **Contrasting Color.** The submerged surface shall be of a dark color so as not to be visible to the skier. The exposed part above the waterline shall be of a light color.
- (E) **Strength and Stiffness.** The jump-ramp surface shall be the equivalent of 19mm marine plywood in strength and stiffness, suitably braced and with smooth integral or glued safe surfacing.
- (F) **Buoyancy.** Suitable buoyancy properly placed shall be used to ensure stability and the dimensions set out in 1603(A) and (B).
- (G) **Center Lines.** Centerline markings of a strongly contrasting color shall be placed at:

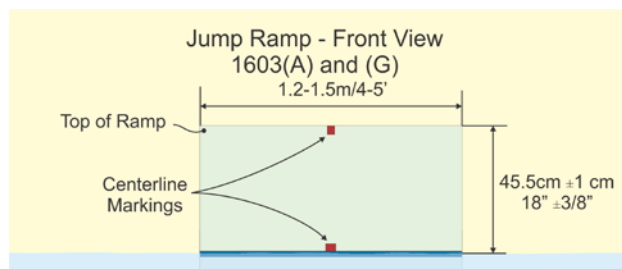

- (1) On the front face of the ramp at the **top of the ramp to facilitate surveying.**
- (2) At the waterline to facilitate measuring to the inner and outer course buoys.

CHAPTER 17: WORLD RECORDS

1701: RECOGNITION

The WBC shall recognize world records for jump distance, slalom crossings, and tricks points for all divisions. The Confederations are permitted to recognize records for divisions other than those recognized by the WBC. The nationality of the skier rather than the location of the tournament shall determine the Confederation and Federation in which a record is recognized.

1702: TOURNAMENT

(A) Where Set. Records shall be set only at tournaments homologated by the WBC, a Confederation, or an Affiliated Federation.

(B) Record Capable Rounds.

- (1) No more than three rounds are permitted in any one competition, except that four rounds are eligible in a head-to-head competition.
- (2) Record eligible rounds shall be declared before the start of the competition.

1703: JUMP

If the longest official distance credited in the Jump Event of a RC tournament exceeds the official record by 10cm or more, it shall be considered for a new World Record.

1704: SLALOM AND TRICKS

If the highest score in the Slalom or Tricks events of a RC tournament exceeds the official record, it will be considered for a new World Record.

1705: EQUAL PERFORMANCE

If a World Record score is equaled at a RC tournament, it will be considered for co-holding the World Record.

1706: AFFIDAVIT—CLAIM DOCUMENTATION

(A) Homologator. Specifications of equipment, courses, and measuring devices shall be as specified in the WBC Technical Rule book and on the Official World Record Forms, which shall be completed and certified by the Homologator and all other required officials.

(B) Review in Descending Order. All performances in all record eligible rounds equal to or exceeding the existing record shall be put forward, and reviewed in descending order until the best that can be verified is established.

(C) Qualified Review. The most qualified officials available shall review the claim and all details as per 1706(D) and 1706(E) while at the tournament. Whenever possible, the Confederational Record Review Committee member should be included in the review of the claim before submission to the RRC Chairman. If this reviewing panel is satisfied that it's valid and the paperwork is in order, the claim shall be put forward as per 1706(F).

(D) Slalom and Trick Records. For Slalom and Tricks records, the original Boat Judges scoring sheets and an electronic copy of the recording of the passes constituting the record taken from the towboat shall accompany the record application.

(E) Jump Record. A jump record application shall include the electronic set-up file and two images: one image of the landing box and one of the jump landing. To ensure that the skier does not obscure the landing box buoys that are necessary for record review, an image of the landing box with no skier using the same camera set-up as the record claim image is necessary.

(F) Submission Deadline. The Homologator shall send a completed record application form, all electronic media, score sheets, and a copy of the homologation dossier to each member of the WBC Record Review Committee within fourteen days of the completion of an event.

Note: Refer to www.WorldBarefootCouncil.com for application and contact details.

- (G) **Confirm Receipt of Application.** The Chairperson of the WBC Records Review Committee (RRC) is to confirm receipt of the record application via E-mail to the submitting Federation within one week of receipt.

1707: VERIFICATION

- (A) **RRC Membership.** The RRC shall consist of one representative from each Confederation. The RRC shall adjudicate all World Records.
- (B) **Decision Within 30 Days.** Within 30 days of the receipt of records, documents, and media, the RRC shall assess and promulgate the outcome of the record application.
- (C) **Federation Notified.** The Chairperson of the RRC is to advise the Federation and applicant on the outcome of the record application via E-mail.
- (D) **Slow Motion and Frame/Frame Review.** The RRC is free to use slow motion or frame-by-frame to review a record application.

1708: RECORD APPEALS

- (A) **Review by Entire WBC.** If a member of the RRC is aggrieved by a decision made by that Committee, they have the right to appeal the decision to the WBC. A review process by the entire WBC is then initiated.
- (B) **Review at Next Regular Meeting.** The WBC will itself scrutinize any appealed record application no later than its next meeting.
- (C) **Slalom and Trick.**
- (1) **Item by Item.** The video for a record shall be viewed trick-by-trick or crossing-by-crossing and shall be judged item by item. Each item shall be approved by at least a two-thirds majority of the WBC.
 - (2) **Scored as a Whole.** When all items of a slalom crossing or trick are approved, it shall be considered approved as a whole.

- (D) **Jump.** The cursor position for a jump landing shall be approved by at least a two-thirds majority of the WBC.

1709: RATIFICATION

All WBC Members shall be notified via E-mail of the new record and of the date of ratification as per 1707(B).

1710: RECORDS SET AT WORLD CHAMPIONSHIP

- (A) **Immediate Notification.** The World Scoring Program shall be programmed to highlight any score that exceeds an existing World Record. The Scorers shall immediately forward this information to the Chief Judge, the Homologator, and the Chief Video Officer.
- (B) **Before the End of Championship.** Whenever possible, the RRC shall adjudicate all World Records set at World Championships before the end of the Championships.
- (C) **Substitute RRC Member.** The RRC shall scrutinize, approve or reject all World Records set at the Championships. If any member of the permanent RRC is not in attendance at the Championships or is unable to fulfill the commitment for any other reason, the WBC Chairman shall appoint a substitute committee member from among the Level 1 Judges in attendance. This substitute should be a WBC Member whenever possible.
- (D) **Appeal.** If any RRC member is aggrieved by a decision made by the RRC, the WBC shall scrutinize and approve or deny the pending record at the World Championships.
- (E) **Homologator Responsibilities.** The Homologator shall consult with the RRC Chairman and the Chief Judge immediately upon notification of a pending record to facilitate the preparation of all documentation to enable the immediate review of any pending World Records. The Homologator tasks include:
- (1) Sourcing the original Judge's sheets.
 - (2) Sourcing a copy of the video recording of the pending record.

- (3) Coordinate a panel of Judges and immediately review the pending record.
- (4) Prepare the required paperwork for presentation to the RRC Chairman after the review panel approves the pending record.

(F) Documents to Skier or Team Representative.

The Chief Judge of the World Championships shall provide the Skier or Team Representative all evidence and documentation necessary for substantiating any pending Federation or Confederation record set at the World Championships.

- (G) Others Afforded Access for Record Verification.** The Team Representative and any of his Confederation Council or WBC Members shall also be afforded the facilities to scrutinize the pending Confederation or Federation record or make record verification.

Jump Course Dimensions 1601

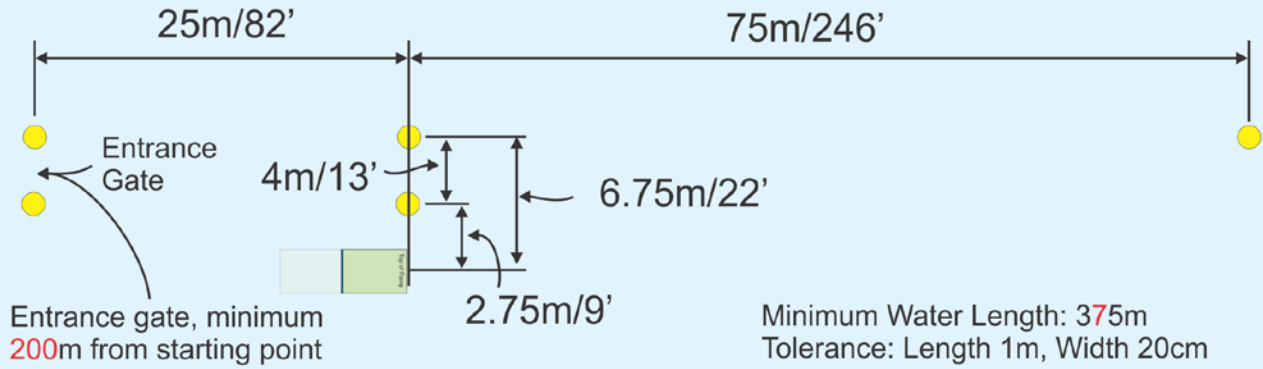

Slalom/Trick Course Dimensions 1602(A)

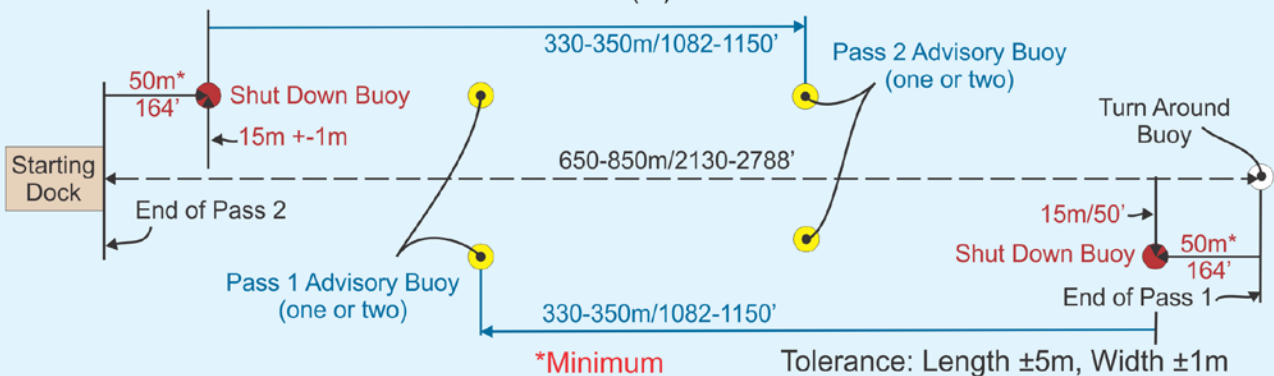

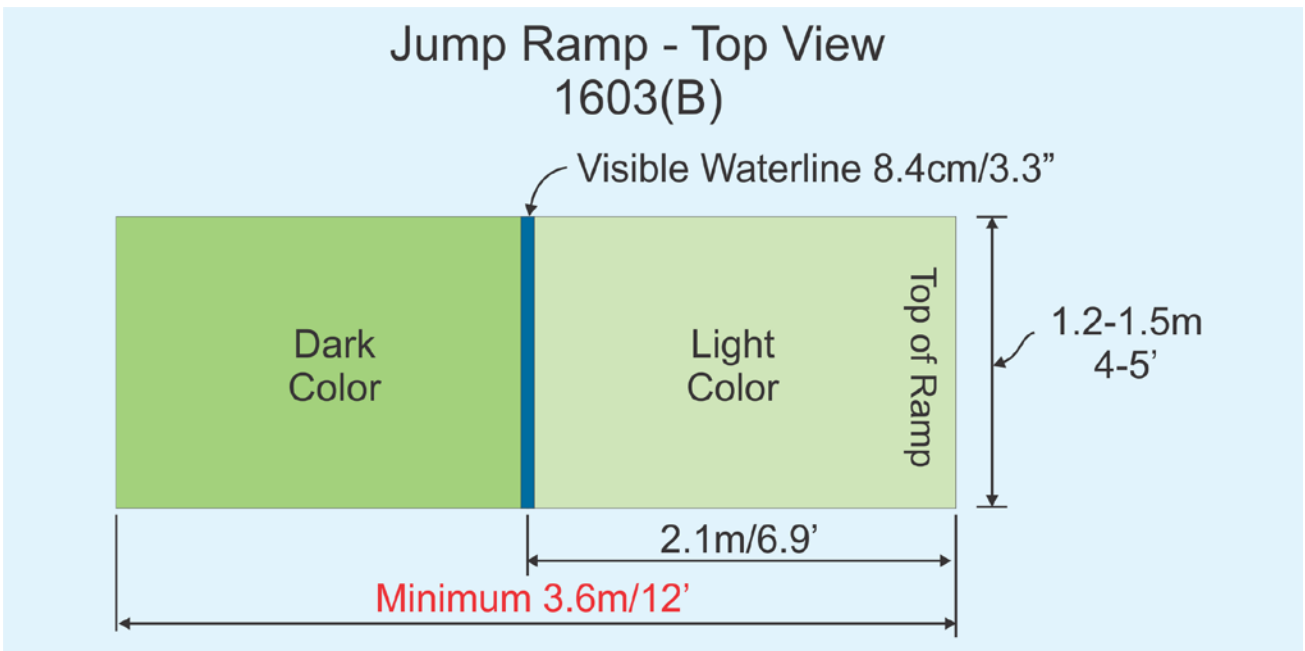
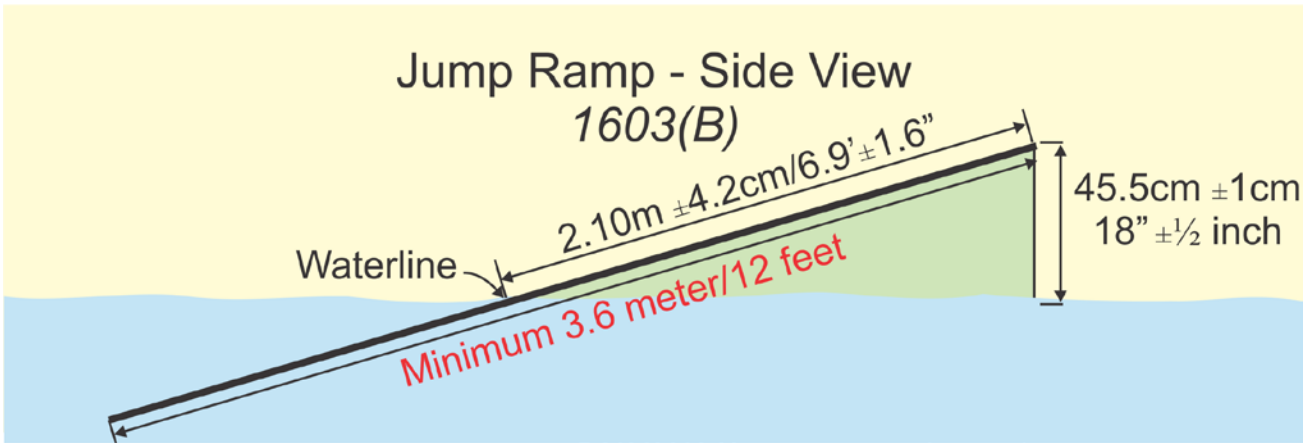

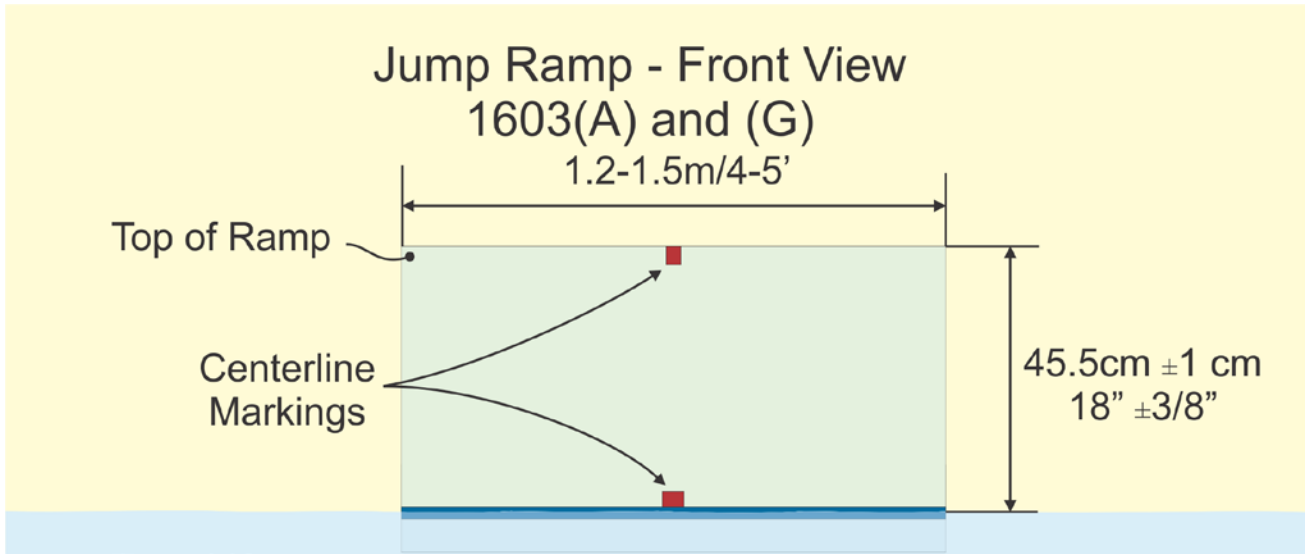

PART II TECHNICAL REQUIREMENTS INDEX

Section Page

Section Page

Part III:

WORLD CHAMPIONSHIPS REQUIREMENTS

CHAPTER 18: General Requirements—World Championship	62
CHAPTER 19: Divisions, Events, and Rounds of Competition— World Championship	64
CHAPTER 20: Entry Requirements—World Championship	67
CHAPTER 21: Overall and Team Ranking—World Championship	70
CHAPTER 22: Officials—World Championship	73
CHAPTER 23: Video—World Championship	75

CHAPTER 18: GENERAL REQUIREMENTS— WORLD CHAMPIONSHIP

1801: SCHEDULING

The World Barefoot Waterski Championships shall be held biennially in even-numbered years and shall be comprised of three Championships with the Open, Junior and Senior World Barefoot Waterski Championships being held concurrently.

1802: SITE CLOSURE AND SET UP

Unless previous homologation arrangements have been agreed to by the Chairman of the WBC and the LOC, the tournament site shall be declared closed at midday on the day prior to the start of the Championship. At that time the towboats, courses and all associated equipment shall be available for homologation.

1803: ON-SITE MEDICAL FACILITIES

The Safety Director shall appoint a Tournament Medical Officer to provide the following services wherever possible:

- (A) **Medical Officer.** A suitably qualified Medical Officer will be in attendance during all tournament events.
- (B) **Medical Station.** A suitably equipped medical station prepared to deal with a medical emergency will be conveniently located at the tournament site.
- (C) **Transportation.** Suitable transportation to safely, and promptly move an injured skier to a local medical unit for additional medical care.
- (D) **Prompt and Qualified Treatment.** A working relationship will be established between the local hospital or medical unit and the Tournament Medical Officer, such that casualties will get prompt and qualified treatment when required.

1804: TOWBOATS

- (A) **Towboat Approval.** The towboats to be used in the World Championships shall be approved by the WBC. Inboard, inboard-outboard or outboard power can be used. This information shall be provided to the Chairman of the Barefoot Council of each Confederation not less than six months before the tournament.
- (B) **Event Boat Selection.** The towboats to be used for each event shall be decided by the Organizers. If more than one type of towboat will be used, the information in 1804(A) shall include a list of the events scheduled for each towboat.
- (C) **Identical Boats.** Identical towboats shall be used for all contestants in a division for each event.

1805: ROPES AND HANDLES

- (A) **Notification.** Information of the type of rope and handles shall be provided to the WBC not less than six months before the tournament. If more than one type of rope and handle will be used, this information shall include a list of the events scheduled for each type of rope and handle.

1806: SAFETY DIRECTOR

- (A) **Appointment.** At least two months before the tournament, the Tournament Committee shall appoint a Safety Director who will appoint such assistants as appears necessary.

1807: DRIVER FAMILIARIZATION

Prior to the start of the tournament the Boat Drivers shall familiarize themselves with the tournament towboats, courses, rates of acceleration, top speed, underwater obstructions, etc. **The Chief Driver shall administer this familiarization so as to ensure all drivers are providing uniform rates of acceleration and lines through the courses.**

1808: COMPLETION

Once a World Championship tournament has started the Chief Judge does not have the authority to cancel any event and the tournament shall be completed, even if obliged to continue in another community, unless the WBC decides otherwise on the recommendation of the Chief Judge.

1809: VALIDITY

The inability of a country to attend the World Barefoot Waterski Championships for any reason does not require that the Championships be cancelled or postponed or that the Championships are any the less World Championships.

CHAPTER 19: DIVISIONS, EVENTS, AND ROUNDS OF COMPETITION—WORLD CHAMPIONSHIP

1901: DIVISIONS OF COMPETITION

(A) Divisions. Competition in each event shall be separated into a Boys, Men and Gentlemen division for male skiers and Girls, Women and Ladies division for female skiers in accordance with 2002.

(1) **Junior Division (Boys/Girls).** The competitors shall be under 17 years of age at midnight on December 31st of the year proceeding the Championships year. Entries of teams and independents shall be accompanied by proof of age.

(2) **Senior Divisions (Gentleman/Ladies).** The competitors shall be 35 years of age or older at midnight on December 31st of the year proceeding the Championships year. Entries of teams and independents shall be accompanied by proof of age.

(B) Dual Entry. Skiers that fulfill the requirements of 2003 are permitted to be entered by their Federation in both the Open and the Junior or Senior World Championships.

1902: EVENTS

The events are Jump, Slalom and Tricks for all divisions.

1903: CHAMPION AND EVENT PLACEMENTS

A champion and succeeding places shall be determined for each event and for the Overall in each division, and for the Federation Teams as described in Chapter 21.

1904: EVENT ROUNDS

(A) Three Rounds. Each event shall consist of three rounds: an elimination round, a semifinal round, and a final round.

(B) Tie Breaking. A run-off to break a tie shall never be considered a round of competition and scores obtained from tie run-offs shall only be used for the purpose of breaking a tie. Run-off scores are not valid for overall scores, a WBC Ranking List score or a record.

1905: SCHEDULE OF EVENTS

(A) Setting up and Announcement of the Schedule.

(1) **Proposed Schedule.** Not later than 60 days before the start of the tournament, the Tournament Chairman shall send a proposed schedule of events to the Chairman of the WBC. Upon approval by the Council, the Tournament Chairman shall disseminate the approved schedule to each affiliated Federation.

(2) **Starting Times.** Two days prior to the start of the tournament, the Tournament Chairman and the Chief Judge shall set starting times for each day.

(3) **Guidance Only.** A schedule of starting times for individual events shall be for the guidance of the skiers, and any time deviation shall not constitute a change in schedule.

(B) Schedule Changes.

(1) **Necessary Changes.** The Chief Judge may make changes in the schedule **that are necessary to the expeditious and safe operation of the tournament.**

(2) **Media Coverage.** Taking account of the importance of media, the Chief Judge is also authorized to make changes designed to increase or improve the coverage.

(3) **Skier Notification.** All affected skiers shall be notified by posting on the official notice board **and by announcement over official PA system.**

(4) **Change Discourage.** Although changes are to be discouraged, the Chief Judge shall not hesitate to make changes dictated by safety.

1906: SITE FAMILIARIZATION

(A) Team Skiers. The LOC is required to ensure that, if requested, each team be allocated, free of charge, an elapsed period between leaving and returning to the dock equal to 8 minutes multiplied by the number of skiers in the team. The division of this time among the team members is the responsibility of the team representative.

(B) Independent Skiers.

- (1) An independent skier entered in the trick and/or slalom event shall be given free of charge familiarization time of **two passes** for each event in which he is entered,
- (2) An independent skier entered in the jump event shall be allowed free of charge familiarization time of one jump,
- (3) An independent skier that is qualified in more than one event may use his familiarization passes for any event he is entered.
- (4) Familiarization for independents shall be scheduled as close to their Federation's team scheduled familiarization time as practical. The LOC shall schedule independents with no Federation team present wherever expedient.

(C) Starting Order. The starting order in familiarization shall, as far as practicable, be in the order of distance traveled from home base, e.g., the further the travel the later the turn.

Note: See PPG for specific site familiarization procedures.

1907: THE DRAW

(A) Seeding Scores. The World Scoring Program rankings database shall be used to generate each skier's seed score as follows:

- (1) Current WSP ranking based on a 12 month period ending 4 weeks prior to the start of competition.
- (2) Skiers without current WSP ranking shall use a score from a 24 month period ending 4 weeks prior to the start of competition.

(3) Skiers with no WSP ranking within 24 month prior to the start of the competition shall be grouped with the lowest seed group after all skiers with WSP seed scores.

(B) Group Divisions. Skiers are divided into groups according to their seeding scores of approximately 15 for men and 10 for women.

1908: STARTING ORDER

(A) Elimination. Before the start of the first elimination round, the entry list shall be closed and thereafter the skier starting order for each group as per 1907(B) shall be in the reverse order of their placement in the seeding scores as per 1907(A); and such starting order shall be posted.

(B) Semifinal. In the semifinal round of an event, the starting order of the semifinalists shall be in the reverse order of their placement in the elimination round of that event.

(C) Final. In the final round of an event, the starting order of the finalists shall be in the reverse order of their best score from either the semifinal or the elimination round of that event.

(D) Change of Order. Only the Chief Judge may change the skier starting order, except that a team representative may:

- (1) Withdraw a skier from the competition.
- (2) Replace, with the authority of the Chief Judge, an injured a skier with a qualified reserve from the same team as per 2002(D).

(E) Ties. Any ties in starting order placement shall be broken by the flip of a coin.

1909: SEMIFINALS

(A) Positive Score Required. To be eligible for the semifinals, a skier shall have a positive score in the elimination round of that event.

(B) Team Skiers. The number of team skiers qualifying to go into the semifinals (N) is determined as follows: N is a number between 8 and 12 inclusive.

- (1) **Less than 9 Team Skiers.** If there are less than 9 eligible team skiers, all go into the semifinal.

- (2) **Less than 17 Team Skiers.** If there are less than 17 eligible team skiers, N is equal to 8, or the number of eligible team skiers if less than 8.
 - (3) **17 or 18 Team Skiers.** If there are 17 or 18 eligible team skiers, N is equal to 9.
 - (4) **19 or 20 Team Skiers.** If there are 19 or 20 eligible team skiers, N is equal to 10.
 - (5) **21 or 22 Team Skiers.** If there are 21 or 22 eligible team skiers, N is equal to 11.
 - (6) **More than 22 Team Skiers.** If there are more than 22 eligible team skiers, N is equal to 12.
- (C) **Ties Between Team Skiers.** If there is a tie between team skiers for their Nth place, the following shall apply:
- (1) **Two Skiers.** If there are two team skiers in the tie, then both go into the semifinal round.
 - (2) **More than Two Skiers.** If there are more than two team skiers in the tie then the Chief Judge shall decide whether to:
 - (a) Have all of the tied team skiers in the semifinals.
 - (b) Have none of the tied team skiers in the semifinals.
- (D) **Independent Skiers.** In addition to the N team skiers, all independent skiers placed above the first N team skiers on the elimination results list shall qualify to go into the semifinals.
- (E) **Nth Place Tie.** If there is a tie for Nth place between team and independent skiers, the Chief Judge shall decide whether to allow all or none of the Nth placed independent skiers to go into the semifinals. No tied independent skier shall go into the semifinals unless all tied team skiers in that division go into the semifinals.

1911: FINALS

- (A) **Positive Score.** To be eligible for the final, a skier shall have a positive score in the elimination round of that event. No distinction shall be made between team and independent skiers when deciding who goes into the finals.
- (B) **Who Qualifies.** The final round of an event will always comprise five skiers, unless fewer make a positive score in the elimination round or a qualified skier is unable to compete due to illness, injury or other reason.

Note: A skier is not required to ski in the semifinals to be eligible to ski in the finals.

- (1) **First Three Skiers.** The first three skiers, based on the results of the semifinal round, shall be qualified to ski in the final round of that event. When the top three skiers from the semifinals have been selected, all their scores shall be removed from a copy of the combined results list of the first two rounds of the event.
- (2) **Next Two Skiers.** The skiers having the two top remaining scores on the combined event results list shall go into the finals.
- (3) **Last Qualifier Tie.** Ties for last qualifying place shall be broken as follows:
 - (a) **Jump.** Each tied skier shall be allowed three jumps to break the tie. This run-off shall proceed until the tie has been broken. The running order shall be determined by the flip of a coin.
 - (b) **Slalom.** Each tied skier shall be allowed two passes to break the tie and this run-off shall proceed until the tie has been broken. The running order shall be determined by the flip of a coin.
 - (c) **Tricks.** Each tied skier shall be allowed two passes to break the tie and this run-off shall proceed until the tie has been broken. The running order shall be determined by the flip of a coin.

CHAPTER 20: ENTRY REQUIREMENTS— WORLD CHAMPIONSHIP

2001: NATIONALITY

Each Federation shall certify to the WBC that all team and independent skiers meet all of the following qualifications:

- (A) **Citizenship/Residency.** A Federation may select its team in any manner it desires; however, each team member shall be a citizen, applying for citizenship, or prove residence in that country for at least five years with membership of an affiliated club or Federation. In case of doubt as to the nationality of a competitor, the WBC normally will refer to his passport.
- (B) **Federation Approved.** A Federation shall not select a person for its team who has represented another Federation in a World or Confederation titled event in the past two years, unless the former Federation agreed to the transfer, in which case the period of two years is reduced to 12 months.
- (C) **Membership.** Each competitor shall be a member in good standing of that Federation.

2002: TEAM COMPOSITION

- (A) **Junior Championships (Boys/Girls).** Each Federation affiliated to the IWWF shall have the right to select a team comprised of four members with a maximum of three of any one sex, to represent it in the Junior World Barefoot Championships.
- (B) **Open Championships (Men/Women).** Each Federation affiliated to the IWWF shall have the right to select a team comprised of six members with a maximum of five of any one sex, to represent it in the Open World Barefoot Championships.
- (C) **Senior Championships (Gentlemen/Ladies).** Each Federation affiliated to the IWWF shall have the right to select a team comprised of four members with a maximum of three of any one sex, to represent it in the Senior World Barefoot Championships.

(D) **Reserve Skiers.** Each Federation shall furthermore have the right to nominate two reserve skiers to each team. Prior to the start of the tournament and at the discretion of the Team Representative, reserve skiers may be substituted in for any reason. **After the start of the tournament skiers shall only be replaced by reserves due to injury. The injured skier shall not compete in the tournament after replacement is made.**

- (1) A reserve skier shall take part only in those events of which the elimination round has not yet started at the time the replacement is made.
- (2) The reserve skiers, if not called upon shall have the right to ski as independents if so qualified.
- (3) Reserve skiers replacing skiers of the opposite sex shall not participate in any event in which the elimination round for the skier they are replacing has started at the time the replacement is made, e.g. a male reserve who is replacing a female skier shall not ski in a male jump if the female jump elimination round has already started.
- (4) Any scores posted by a reserve skier while skiing as an independent shall never count toward Team Overall calculations.

(E) **Team Representative.** Each team shall select a representative whose name shall be given to the Chief Judge before the start of the tournament.

(F) **Independent Representative.** Federations shall select a representative whose name shall be given to the Chief Judge before the start of the tournament.

2003: INDEPENDENT ENTRANTS

(A) Qualification Scores. Skiers not selected for their National teams may qualify to compete in the World Championships as independents by achieving a qualifying score as follows:

Qualifying scores for all divisions and events shall be determined by using the World Rankings List from the year of the most recent World Championships in the following way:

- (1) Less than 16 RL Skiers. The qualify score shall be based on the 8th RL rated skier.
- (2) 17 or 18 RL Skiers. The qualify score shall be based on the 9th RL rated skier.
- (3) 19 or 20 RL Skiers. The qualify score shall be based on the 10th RL rated skier.
- (4) 21 or 22 RL Skiers. The qualify score shall be based on the 11th RL rated skier.
- (5) 23 or 24 RL Skiers. The qualify score shall be based on the 12th RL rated skier.
- (6) 25 or 26 RL Skiers. The qualify score shall be based on the 13th RL rated skier.
- (7) 27 or 28 RL Skiers. The qualify score shall be based on the 14th RL rated skier.
- (8) 29 or 30 RL Skiers. The qualify score shall be based on the 15th RL rated skier.
- (9) 31 or 32 RL Skiers. The qualify score shall be based on the 16th RL rated skier.
- (10) 33 or 34 RL Skiers. The qualify score shall be based on the 17th RL rated skier.
- (11) 35 or 36 RL Skiers. The qualify score shall be based on the 18th RL rated skier.
- (12) 37 or 38 RL Skiers. The qualify score shall be based on the 19th RL rated skier.
- (13) 39 or More 40 RL Skiers. The qualify score shall be based on the 20th RL rated skier.

- *Note. The “nth” RL rated skier is found by counting that number of skiers down from the first skier on the list. EG. If there are tied skiers they still take up one place each on the list. If in a list of 10 skiers there is a 4 way tie on the third highest score the 10th skier on the list is the “10th RL rated skier.”*
- *The Minimum Standard for Jump in all divisions shall be 8 meters regardless of the number of skiers on the Rankings List or the lowest score on the Rankings List for that division.*
- *The qualifying period shall start the day after the conclusion of the most recent World Championships and shall conclude 4 weeks prior to the upcoming World Championships.*

Note: See PPG for guidelines.

- (B) Previous World Champions and Record Holders.** All previous World Overall and World Event Champions, and all current World Record Holders, are eligible for entry to the World Barefoot Championships with the endorsement of their Federation without regard to 2003(A). Event Champions and record holders can only enter those events in which they are previous World Champions or current record holders. Previous Overall champions may enter any or all events. This rule does not qualify Junior or Senior Champions to compete in the Open Championships. *This rule does not qualify Junior Champions to compete in the Junior Championships unless they meet the age requirements as set out in 2002(A).*
- (C) Federation Entry.** Their Federation shall enter all skiers qualified as independents.
- (D) Overall Points.** Skiers entered as independents shall be awarded overall points for the events in which they qualify.
- (E) Team Overall.** Independent skier’s overall scores shall not affect team overall scores.

2004: JUMP PROFICIENCY

- (A) Ranking List.** Skiers entering the Jump Event must have achieved one of the following proficiencies:
- (1) A positive jump score on the current WBC Rankings List.

- (2) A positive jump score in a WBC Rankings List tournament up to four weeks prior to the World Championships.

(B) Non-Ranking List. Skiers entered in the jump event from countries that have not held WBC Rankings List tournaments during the qualifying period shall be certified by the Chairman of that Confederation.

Note: No skier will be allowed to jump if, in the opinion of the Chief Judge, Safety Director and a simple majority of the Event Judges, his competing would be a danger to himself [210(B)].

2005: ENTRY REGISTRATION

(A) Intent to Compete

- (1) **Eight Weeks.** Not later than eight weeks before the scheduled start of the tournament, each Federation intending to field a team and/or Independents in the World Barefoot Waterski Championships shall certify to the Chairman of the WBC and to the Organizing Committee its intent to compete and their estimated entries on the Intent to Enter Form.

Note: See PPG for "Intent to Enter Form."

- (2) **Late Fee.** Any Federation not meeting this requirement shall not be allowed to compete until they pay a fine of \$200 (USD) to the World Barefoot Council.

(B) Definitive Entry

- (1) **Team Skiers.** Not later than four weeks before the scheduled start of the tournament, each Federation intending to enter a team shall certify to the Chairman of the WBC, the Chairman of the Confederation Barefoot Council and the Organizing Committee, the names of the skiers (Maximum of six for Open, four for Junior, and four for Senior) **that will be skiing team members**, and the events each will enter on the Definitive Entry Form. The names of up to two reserves for each team shall also be submitted at this time on the same form.
- (2) **Independent Skiers.** Not later than four weeks before the scheduled start of the tournament, each Federation shall submit the names of any of its qualified independent skiers it wishes to enter, and the event or events they will enter on the Definitive Entry Form.
- (3) **Late Fee.** Any Federation not meeting these requirements will not be allowed to compete until the Federation pays to the WBC a fine of \$10 (USD) per skier per day after the four week deadline, for each skier not officially entered.

Note: See PPG for "Definitive Entry Form."

CHAPTER 21: OVERALL AND TEAM RANKING— WORLD CHAMPIONSHIP

2101: EVENT PLACING

- (A) **Placement.** Event placing shall be based on the final round, followed by the semifinal round and elimination round results.
- (B) **Medal Round.** If no final round can be held due to force majeure, then the final medal placement of skiers shall be determined by using the best score registered by each skier in either the elimination round or semifinal round of the event.

2102: CHAMPIONS

All divisions shall have champions in Jump, Slalom and Tricks, and an Overall Champion. There will be no event champion in events in which there are less than three competitors.

2103: TIES

- (A) **Gold Medal Tie.** If there is a tie for the gold medal in any event the following rules shall apply:

- (1) **Jump.** A run-off of three jumps per skier between the tied skiers shall be used to break the tie. This run-off shall proceed until the tie has been broken. The order of skiing shall be determined by the flip of a coin. The skier posting the highest score in the run-off shall be declared the event champion, and the skier posting the lower score shall be the silver medalist.
- (2) **Slalom.** A run-off of two passes per skier between the tied skiers shall be used to break the tie. This run-off shall proceed until the tie has been broken. The order of skiing shall be determined by the flip of a coin. The skier posting the highest score in the run-off shall be declared the event champion, and the skier posting the lower score shall be the silver medalist.

- (3) **Tricks.** A run-off of two passes per skier between the tied skiers shall be used to break the tie. This run-off shall proceed until the tie has been broken. The order of skiing shall be determined by the flip of a coin. The skier posting the highest score in the run-off shall be declared the event champion, and the skier posting the lower score shall be the silver medalist.

- (4) **Run-off Not Possible.**

- (a) **Jump.** Should a run-off not be possible due to weather, force majeure, or injury through no fault or action of the skier, then the longest jump attained by a tied skier from any round of the competition shall be declared the event champion and the other tied skier shall be declared the silver medalist. Should the skiers still be tied, then the second longest jump attained by a tied skier from any round of the competition shall be declared the event champion and the other tied skier shall be declared the silver medalist.

- (b) **Slalom or Tricks.** Should a run-off not be possible due to weather, force majeure, or injury through no fault or action of the skier, then the highest score attained by a tied skier from any round of the competition shall be declared the event champion and the other tied skier shall be declared the silver medalist. Should the skiers still be tied, then the second highest score attained by a tied skier from any round of the competition shall be declared the event champion and the other tied skier shall be declared the silver medalist.

- (B) **Silver Medal Tie.** In the event of a tie for the silver medal, all tied skiers shall be awarded a medal and there shall be no bronze medal award.

(C) **Bronze Medal Tie.** In the event of a tie for the bronze medal, all tied skiers shall be awarded a medal.

2104: OVERALL SCORING—APPLICATION

(A) **Team Overall Points.** Team overalls are based on scores made by team skiers in the elimination and semifinal rounds, as they stand before the final round commences.

- (1) Team Overall points are used to calculate the team results only.
- (2) Team Overall points are definitive for team results.

Note: Team scoring requirements are contained in 2108.

(B) **Individual Overall.** Individual Overalls are based on scores made by all skiers, including independent skiers, in all rounds and are used to calculate the individual event overall rankings. Individual Overall points are used for all divisions, and thus determine the Individual Overall Champions and succeeding places. They shall not be used for the team results.

2105: OVERALL SCORING—CALCULATION

(A) **Team Overall Points.** The best score by any team skier in either the elimination or the semifinal round of an event shall be awarded 1000 Team Final Overall points and shall be used to calculate the Team Overall points for all team skiers.

(B) **Team Skiers Overall Points.** All other performances by team skiers in those rounds shall be calculated according to the following formula, where the term “top performance” refers to the best score by a team skier in either the elimination or the semifinal round of the event.

Team Skier's Overall = Team skier's best score x 1000 / top performance [2105 (A)]

(C) **Rounding.** Event and Overall scores shall be rounded to two decimal places.

(D) **Individual.** The best score by any skier, including independent skiers, in any round of an event shall be awarded 1000 Individual Overall points and shall be used to calculate the Individual Overall points for all skiers. Scores obtained in running off a tie shall not be taken into account in the overalls.

(E) **Individual Overall Points.** All other performances by skiers in all rounds shall be calculated according to the following formula, where the term “top performance” refers to the best score by any skier in any round of the event.

Individual Overall Points = Skier's best score x 1000 / top performance [2105(D)]

2106: QUALIFICATION FOR OVERALLS

To be considered for overall placing, a skier shall post a positive score in at least one event.

2107: OVERALL PLACING

Places in the Overall Championship shall be determined by totaling each skier's overall points as detailed in 2105.

2108: TEAM PLACING

(A) Open Team

- (1) In Open Team scoring the best three overall scores per team, men and/or women, in each event, as detailed in 2105(B), shall be totaled to obtain the team score.
- (2) The three skiers whose results are used for a team score may differ from event to event.
- (3) The skiers whose scores are used in team scoring shall be identified on the team results.

(B) Junior Team.

- (1) In Junior Team scoring, the best two overall scores per team, boy and/or girl, in each event, as detailed in 2105(B) shall be summed to obtain the team score.
- (2) The two skiers whose results are used for a team score may differ from event to event.
- (3) The skiers whose scores are used in team scoring shall be identified on the team results.

(C) Senior Team.

- (1) In Senior Team scoring, the best two overall scores per team, gentleman and/or lady, in each event, as detailed in 2105(B) shall be summed to obtain the team score.
- (2) The two skiers whose results are used for a team score may differ from event to event.
- (3) The skiers whose scores are used in team scoring shall be identified on the team results.

2109: SCORE SHEETS ACCESS

- (A) Team Representative.** For the first 10 minutes after event results posting, team representatives may only view the scoring sheet(s) of their own skiers.
- (B) All Skiers.** Eleven minutes after result posting, team representatives shall have access to the score sheet(s) of any competitor in that event.
- (C) Skier Access.** After event results have been posted, skiers shall have access to their own scoring sheets under the direct supervision of the team representative.
- (D) Viewing Area.** Score sheets shall not be removed from the designated viewing area.

CHAPTER 22: OFFICIALS—WORLD CHAMPIONSHIP

2201: CHIEF OFFICIALS

- (A) **Nomination Deadline.** No later than nine months prior to the World Championships, Confederations or WBC members shall submit nominations in the form of a resume to the Secretary of the WBC for the positions of Chief Judge, Assistant Chief Judge, Chief Scorer, Chief Driver, Chief Video Operator, Homologator and Tournament Director.
- (B) **WBC Approval Deadline.** No later than eight months before the World Championships, the WBC shall make their recommendation for appointments by simple majority vote. The Chairman of the WBC shall then submit the recommended nominations to the President of the IWWF.
- (C) **Appointment by IWWF Deadline.** No later than seven months before the World Championships, and on the recommendation of the WBC, the President of the IWWF shall appoint the above-mentioned positions for the World Championships.
- (D) **Different Confederations.** The Chief Judge, Assistant Chief Judge and Chief Scorer shall be from different Confederations whenever possible.
- (E) **Chief Driver.** The Chief Driver shall be in addition to the three Drivers appointed from each of the three Confederations.
- (D) **Notification of Appointment.** The IWWF President shall inform the Confederation Chairmen and the Appointed Officials of these appointments via E-mail within one week of the decision.
- (E) **Qualifications.** The Nominated Judges, Scorers and Drivers shall be Level 1.
- (F) **Appointed Officials.** Four Judges, one Scorer and one Driver shall represent each of the three Confederations.
- (G) **Reserve.** Each Confederation may provide a Reserve Judge, Scorer or Driver for replacement(s) as deemed necessary by the Chief Judge. Whenever possible the Reserve, if used, shall come from the Confederation where the vacancy is.
- (H) **Insufficient Quantity.** If there are not enough qualified officials available from any Confederation, the Chairman of the Council shall select additional officials from other Confederations.
- (I) **Supervision.** The Chief Judge shall select Event Judges and Assistants for each event and shall supervise all judging and scoring operations. The Chief Judge and the Assistant Chief Judge shall not serve in the towboat.
- (J) **Exclusion.** Officials appointed by the WBC, including the Safety Director and any other appointed personnel who have unequal access to video footage of the Championships, shall not be permitted to ski in the World Championships.

2202: APPOINTED JUDGES, SCORERS AND DRIVERS

- (A) **Nominations.** Confederations or WBC members shall submit nominations in the form of a resume for the above-mentioned positions to the Secretary of the WBC no later than eight months prior to the World Championships.
- (C) **Approved by WBC.** No later than six months before the Championships the Judges, Scorers and Drivers for the World Championships shall be appointed by a simple majority vote the WBC from the lists submitted by the three Confederations.

2203: SECONDARY POSITIONS

- (A) **Secondary Positions.** Personnel to fill secondary positions shall be selected by the Chief Judge from other experienced Judges and officials in attendance.
- (B) **Announcer.** Announcers are appointed by the local organizing committee and are to serve under the authority of the Chief Judge.

- (C) **Secretary.** A Chief Judge's Secretary shall be appointed by the Organizers to provide administration support to the Chief Judge. The Secretary shall be computer literate, have high levels of administration skills and good local knowledge of the Organizer's personnel and facilities.
- (D) **Pick-Up Drivers.** Pick-up drivers shall be provided by LOC and shall be trained in water rescue techniques. *Whenever possible, the Chief Judge shall assign an appointed official to be the pick-up driver so they can monitor changing water conditions throughout events.*
- (E) **Dock Official.** Dock officials shall be provided by LOC and assigned by the Chief Judge. *Whenever possible, the Chief Judge shall assign an appointed official to the starting dock to monitor the conditions and observe boat paths.*

2204: INDEPENDENCE

Where possible, Event Judges shall be separated to ensure completely independent opinions. Until the expiry of the protest period the Event Judges shall not confer on their score except to determine the last trick in time [714(D)] or to provide provisional results when an optional re-ride is offered in accordance with 1003.

2205: REPLACING OFFICIALS

The Chief Judge is permitted to replace Event Judges and Drivers during an event at his discretion. Such change-over shall take place between groups.

2206: AFFIDAVIT

The Chief Judge and each Appointed Official shall sign a statement on the prescribed form at the conclusion of the tournament that the rules were followed implicitly, noting any exceptions allowed.

CHAPTER 23: VIDEO—WORLD CHAMPIONSHIP

2301: APPOINTMENTS

- (A) **Video Operators.** The host Federation of a World Championship shall appoint a **minimum** of three suitably experienced Video Operators who shall be responsible to the Chief Video Operator.
- (B) **Video Camera.** A video camera shall be used to make a permanent record of all events.

2302: AVAILABILITY

- (A) **Official Assistance.** The video recording forms the official assistance to the Chief Judge, the Event Judges, and the WBC.
- (B) **Available to IWWF.** For this purpose, the original or a good copy shall be made available, free of charge, on-site to the IWWF for internal use.

2303: BOAT LOADING

- (A) **Ballast Added.** Should a camera operator leave the towboat during an event, sufficient ballast shall be placed in the towboat for the remainder of the event to avoid a significant change to the towboat wake.
- (B) **Ballast Removed.** Should a camera operator board the towboat during an event, sufficient ballast shall be removed from the towboat for the remainder of the event to avoid a significant change to the towboat wake.
- (C) **Two Camera Operators.** Two camera operators authorized in 1302 shall be allowed to ride in the towboat at the same time if the towboat wake is not adversely affected to a significant degree.

PART III TECHNICAL REQUIREMENTS INDEX

Section Page

Section Page