

2011 EDITION

BAREFOOT WATER-SKI TECHNICAL RULES — 2011



This book belongs to:

Copyright 2011 by International Waterski & Wakeboard Federation (IWWF) - World Barefoot Council. All Rights Reserved.

Reproduction of any part or whole of this document is prohibited unless written permission has been obtained from the IWWF World Barefoot Council.

Released March 7, 2011

THE GREATEST BAREFOOT AMBASSADOR OF THEM ALL!



BANANA GEORGE BLAIR

George remains the true inspiration for all of us. In his 96th year, he still continues to promote our sport at all levels and to all people.

Twenty-six years ago, George first sponsored the printing of the International Waterski and Wakeboard Federation's World Barefoot Council Technical Rule Book. George continues to support and inspire the World Barefoot Council to ensure that our skiers and officials have the tools and rules they need to keep the Barefoot playing field level for everyone.

The World of Barefooting salutes you George.

SUMMARY OF CHANGES FOR 2011

Every change in text from the 2010 Rule Book has been highlight in RED. In the majority of instances these were simply “housekeeping” issues such as spelling, incorrect numbering, or wording to better clarify the intent of the rule. There were some actual changes made to the rules that affect the outcome of performances, equipment requirements, or administrative items; those changes are listed as follows:

- 307 – Definition of World Scoring Program added with note in how to access it.
- 308 — Start order to be seeded by reverse order of seed rating score.
- 405 — Deleted Preliminary Entry form and changed submission times
- 503(B) and (C) — Awarding of metals for Silver and Bronze placement ties revised.
- 1103 (D) (6) — Standardized leader requirements added.
- 1509 (C) — Added “leg” requirement to perfect one-foot cross credit.
- 1612 (A) — Changed requirements for one hand credit.
- 1612 (E) (4) — Neck trick to be discontinued after 2012 World Championship.
- 1612 (G)(4) — Teeth trick to be discontinued after 2012 Worlds Championship.
- 1706 (F) — World Record submission time extended to 14 days.

CONTENTS

CHAPTER 1: DEFINITIONS AND COURSE REQUIREMENTS	1	CHAPTER 5: EVENT, OVERALL AND TEAM RANKING	15
100: Introduction	1	501: Event Placing	15
101: Convention	1	502: Champions	15
102: Definitions.....	1	503: Ties.....	15
103: Jump Course	2	504: Overall Scoring—Application	16
104: Slalom and Trick Course	2	505: Overall Scoring—Calculation	16
105: Skier Instructions	3	506: Qualification for Overalls	16
106: Turn-Around Times.....	5	507: Overall Placing	16
108: Emergency Minute.....	5	508: Team Placing	16
CHAPTER 2: GENERAL REQUIREMENTS	6	509: Results Posting	17
201: Application.....	6	510: Score Sheets	17
202: Scheduling.....	6	CHAPTER 6: OFFICIALS	18
203: Exceptions to the Rules	6	601: Chief Officials.....	18
204: Interpretation of the Rules	6	602: Appointed Judges, Scorers and Drivers.....	18
205: Rules Revision.....	6	603: Secondary Positions	18
206: Amendments to the Rules	6	604: Independence	19
207: Rule Change Procedure	6	605: Replacing Officials	19
208: Validity	7	606: Affidavit	19
209: Voting.....	7	607: Minimum Requirements for Boat Officials.....	19
210: Site Closure and Set Up.....	7	CHAPTER 7: VIDEO	20
CHAPTER 3: DIVISIONS AND EVENTS	8	701: Appointments.....	20
301: Divisions of Competition.....	8	702: Assignment.....	20
302: Events	8	703: Availability.....	20
303: Event Rounds.....	8	704: Media	20
304: Schedule of Events.....	8	705: Boat Loading	20
305: Site Familiarization	8	706: Official Use	20
306: Driver Familiarization	9	CHAPTER 8: SAFETY	21
307: the Draw.....	9	801: Safety Director.....	21
308: Starting Order.....	9	802: Flotation and Protection	21
309: Semifinals.....	9	803: Helmets.....	21
310: Finals	10	804: Temporary Incapacitation	21
311: Completion	10	805: Safety Personnel	21
312: Interruptions and Stoppage	10	806: On-Site Medical Facilities.....	22
313: Disqualification	11	CHAPTER 9: RE-RIDES	23
CHAPTER 4: WORLD CHAMPIONSHIP ENTRY REQUIREMENTS	12	901: When A Re-Ride Is Granted/Required.....	23
401: Team Composition.....	12	902: Re-Rides in the Jump Event	23
402: Nationality	12	903: Re-Rides in the Slalom Event	23
403: Jump Proficiency.....	13	904: Re-Rides in the Trick Event	23
404: Certification	13	905: Re-Ride Request.....	24
405: Entry Registration.....	13	906: Not Basis for A Re-Ride.....	24
406: Independent Entrants.....	13	907: Same Instructions	25
		908: Refusal to Enter Course	25
		909: Provisional Scores.....	25

CHAPTER 10: PROTESTS	26	CHAPTER 16: TRICKS EVENT	39
1001: Procedure.....	26	1601: Equipment	39
1002: Basis.....	26	1602: Passes	39
1003: Chief Judge Decision	26	1603: Starting	39
1004: Fee	26	1604: Towboat Speed and Path	42
1005: Calculation Error	26	1605: Start of Pass	42
CHAPTER 11: TOWBOATS, ROPES, HANDLES, AND TIMERS	27	1606: End of Pass	42
1101: Boat Specifications.....	27	1607: Officials	43
1102: World Championships	28	1608: Credit for Pass Tricks	43
1103: Ropes and Handles.....	28	1609: Bonus Actions	45
1104: Timers.....	29	1610: Penalties and Reversions	45
CHAPTER 12: SPEED CHECKS	30	1611: Precursory Tricks	46
1201: Method.....	30	1612: General Pass Tricks	47
1202: Top Speed Advisory.....	30	1613: Turn Tricks General.....	49
CHAPTER 13: COMMUNICATIONS AND VIDEO EQUIPMENT	31	1614: 180 Back-To-Front	50
1301: Communications	31	1615: 180 Front-To-Back	50
CHAPTER 14: JUMP EVENT	32	1616: 360 Front-To-Front.....	51
1401: Jump Ramp	32	1617: 360 Back-To-Back	51
1402: Starting	32	1618: 540 Turns.....	51
1404: Boat Speed and Path.....	32	1619: 720 Turns.....	52
1405: Start of Pass—Jump Attempt.....	33	1620: Step-Over Line Turn	52
1406: Passes—Jumps	33	1621: Rope-On-Foot Turn	53
1407: Officials	33	1622: Somersault.....	53
1408: Credit for Jump	33	1623: Scoring – Trick Point Values	54
1409: Scoring	33	1624: New Tricks.....	54
1410: Jump Measurement and Calculation	34	CHAPTER 17: WORLD RECORDS	55
1412: Distance	34	1701: Recognition.....	55
CHAPTER 15: SLALOM EVENT	35	1702: Tournament.....	55
1501: Equipment	35	1703: Jump.....	55
1502: Passes	35	1704: Slalom and Tricks	55
1503: Starting	35	1705: Equal Performance	55
1504: Boat Speed and Path.....	35	1706: Affidavit—Claim Documentation.....	55
1505: Start of Pass	35	1707: Verification.....	56
1506: End of Pass	36	1708: Record Appeals.....	56
1507: Officials	36	1709: Ratification.....	56
1509: Credit for Slalom.....	36	1710: Records Set At World Championship	56
1510: Scoring	38	INDEX	58
		GRAPHICS AND TABLES	60

CHAPTER 1: DEFINITIONS AND COURSE REQUIREMENTS

100: INTRODUCTION

These rules have been drafted in English. In case of conflicting interpretation, only the English text shall be considered authentic. All correspondence regarding these rules shall be addressed to the Chairman of the World Barefoot Council.

These rules become effective on the 1st of January, 2011 and shall govern all World Barefoot Waterski Championships thereafter until superseded.

101: CONVENTION

Where the words 'he,' 'him', 'his,' 'himself' are used, they shall be held to apply with equal validity to persons of either sex. This convention is not to be construed in any way as a slight on the fair sex, but adopted purely to avoid impairment of the readability of complex text.

102: DEFINITIONS

BSP (Barefoot Skiing Position)

General. BSP is a position in which all of the following exists:

- (1) **Handle.** The skier has possession of the handle.
- (2) **Stable Position.** The skier is riding forward or backward on one or two bare feet in a stable position.
- (3) **Supported by Foot/Feet.** The weight of the skier is entirely supported by the foot or feet.

One-Foot. For the trick event, the entire free foot shall be at least half-way between the skier's other knee and the water surface.

Rope-on-Foot. The skier shall be in stable position with both hands free from the handle and the surface of the water and only the foot holds the handle.

Course Speed. The Skiers requested speed +/- the tolerance for the event.

Fall. Any time after the skier signifies his readiness to commence, any one of the following occurs:

- (1) **Failure.** The skier loses possession of the handle or has total equipment failure, for example, a broken rope or handle.
- (2) **Support.** The weight of the skier is not primarily supported by his foot/feet (except where a skier is supported by other parts of the body as prescribed in the official description of a specific trick or after negotiating the jump) and the skier is unable to regain BSP before the end of the pass.

Force Majeure. Circumstances beyond the control of all parties.

IWWF. International Waterski and Wakeboard Federation, www.IWSF.com.

LOC. Local Organizing Committee.

PPG. Procedures, Policies and Guidelines is the document that contains information, forms and instructions necessary for hosting a World Championship Tournament, as well as the PPG's and interpretations of the WBC.

RC. Record Capable

RRC. WBC Records Review Committee

RL. WBC World Ranking List

WBC. WorldBarefootCouncil, www.WorldBarefootCouncil.com

WSP. World Scoring Program.

Note: A copy of the program is available at no charge from Brian Heeney; send a request via e-mail to heeney@barefoot.org.

Wake. The area of water disturbed by the passage of the towboat lying at rope's length between and including the crest of the wake waves. The crest of the wave is the nominal boundary of the wake and shall be the lift-off points for both Slalom and Tricks.

Outermost Waves. For towboats that create extra waves within the wake, only the crest of the outermost waves shall be considered.

(1) **Crest/Lift-Off Point**

- (a) **Smooth Shoulder.** If the wake wave has a smooth rounded shoulder, the wave crest is the point where the wave shoulder takes a sharp downturn to the outside of the wake.

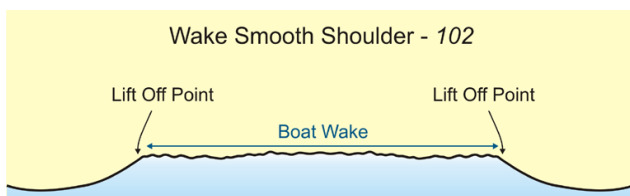

- (b) **Curled Shoulder.** If the wake wave has a curled shoulder, the wave curl is the point of the wave crest.

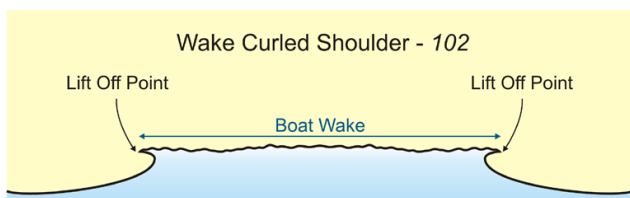
**103: JUMP COURSE**

- (A) **Jump Course.** The Jump course dimensions shall be in accordance with the following:

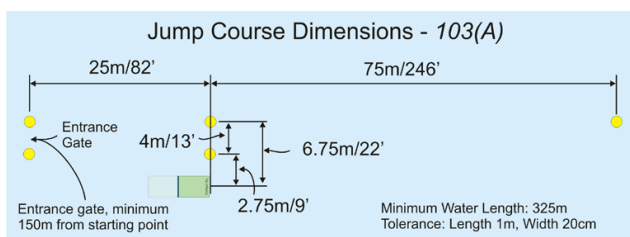

- (B) **Jump Ramp.** The jump ramp shall be set parallel to the jump course. The method of determining this requirement can be either via a surveyed course, a measured course or visual line of sight.
- (C) **Buoys.** No buoys or markers other than those required by 103(A) are permitted within the jump course area except to mark safety hazards and facilitate jump distancing. Any such buoys shall be distinguishable from course buoys and shall be pointed out to team representatives/skiers before the start of the competition.

- (D) **Departure Point.** The departure point for the jump event shall be not less than 150m before the jump course entrance gate and shall be as close as possible to an extension of the course line.

104: SLALOM AND TRICK COURSE

- (A) **Course Dimensions.** The dimensions of the courses shall be as indicated in the following figure; however, the layout of the competition area is permitted to be varied to suit the tournament site. The competition site shall encompass a starting dock, skier advisory buoys for both passes, shutdown buoys for both passes, and a turn-around buoy at the far end.

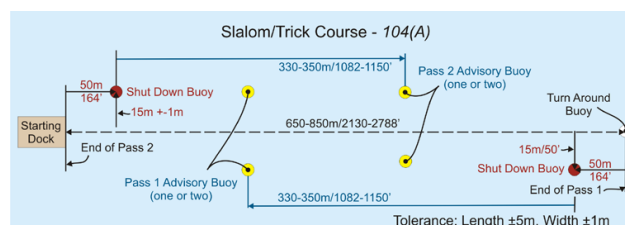

- (1) **Dock.** The starting dock shall be as near the extension of the course line as possible.
- (2) **Course Line.** The course lines for the two passes should coincide if possible. If necessary for spectator viewing, the courses is permitted to be angled to or distanced from each other.
- (3) **Turn-Around Buoy.** The distance between the starting dock and the turn-around buoy shall be not less than 650m and not more than 850m. The turn-around buoy shall be on the extended course line.
- (4) **Skier Advisory Buoys.** For both passes, a skier's advisory buoy(s) shall be located between 330m and 350m from the shut-down buoy, approximately 15m perpendicular from the course line on each side of the course.
- (5) **Shut-Down Buoy.** The shut-down buoy shall be approximately 15m from the course line on the Driver's side located a minimum of 50m from the end of course or turn-around buoy.

Note: The shut-down buoy marks the point at which the Driver shall smoothly close the throttle in order to safely stop the towboat before the end of the course.

- (B) Buoys.** No buoys or markers other than those required by 104(A) are permitted within the competition area, except to mark safety hazards, landing or starting areas, or turning buoys. Any such buoys shall be distinguishable from course buoys and shall be pointed out to team representatives/skiers before the start of the competition.

105: SKIER INSTRUCTIONS

The skier's instructions to the Boat Judges prior to starting a pass shall consist of:

(A) Jump Event.

- (1) **Point of Attachment.** The skier shall notify the Boat Judges as to the height of rope attachment, 'low', 'middle', or 'high'; and it's the skier's responsibility to ensure that the rope is attached at the proper height.

Note: No re-rides will be given due to incorrect rope height [906D]].

- (2) **Start Phases.** The requested speed/acceleration in the terms 'slow', 'medium' or 'fast', for the three phases: pull out of the water, ride over the bumps, and acceleration to speed.
- (3) **Path.** Distance from the jump, Wide, Split, or Close in accordance with 1404(B).
- (4) **Course Speed.**

- (a) The requested **course** speed shall be given in units of whole kph or one-half mph up to a maximum of 72 kph/44.7 mph, with a tolerance of ± 1.5 kph or ± 1 mph [1404(A)].
- (b) **On achieving "course speed," the driver shall notify the boat judge(s) by calling "speed on."**

Notes:

- A mandatory re-ride is required if the average speed through the jump course exceeds 73.5 kph/45.7 mph [901(B)(3)].
- **Course speed is defined in 102.**

(B) Slalom Event.

- (1) **Point of Attachment.** The skier shall notify the Boat Judges as to the height of rope attachment, 'low', 'middle', or 'high'; and it's the skier's responsibility to ensure that the rope is attached at the proper height.

Note: No re-rides will be given due to incorrect rope height [906D]].

- (2) **Start Phases.** The requested speed/acceleration in the terms 'slow', 'medium' or 'fast', for the three phases: pull out of the water or off the dock, ride over the bumps, and acceleration to speed.

(a) At the skier's discretion the second phase is permitted to be enlarged with another instruction such as, but not limited to: planing speed, out of the wash, foot plant, or spin around.

(b) The skier is permitted to request an intermediate rpm or speed for planing; ± 200 rpm, ± 5 kph, or ± 3 mph tolerance.

(3) Course Speed.

(a) The **requested course** speed shall be given in units of whole kph or one-half mph, with a tolerance of 1 kph or $\frac{1}{2}$ mph, and shall be limited by the maximum speed attainable by the towboat.

(b) **On achieving "course speed," the driver shall notify the boat judge(s) by calling "speed on."**

Note: Course speed is defined in 102.

- (4) **Request Speed Signal.** The skier may request a signal when the requested course speed is attained. This signal may be requested in the form of sound, a hand signal or a tap/chop on the rope.

(5) **Position.** Whether it will be a forward or backward pass.

(6) **Raise Engine.** The Skier can request the Driver to raise the engine from the default position and is responsible to approve its placement before commencing.

Note: If the skier requests the engine to be trimmed for higher speed, engine position shall never be grounds for a re-ride or protest [906(J)].

(C) Trick Event.

- (1) **Point of Attachment.** The skier shall notify the Boat Judges as to the height of rope attachment, 'low', 'middle', or 'high'; and it's the skier's responsibility to ensure that the rope is attached at the proper height.

Note: No re-rides will be given due to incorrect rope height [906D)].

- (2) **Start Phases.** The requested speed/acceleration in the terms 'slow,' 'medium' or 'fast', for the three phases: pull out of the water or off the dock; ride over the bumps; and acceleration to speed.

(a) At the skier's discretion the second phase is permitted to be enlarged with another instruction such as, but not limited to; speed, out of the wash foot plant, or spin around.

(b) The skier is permitted to request an intermediate rpm or speed for planing; ± 200 rpm or ± 5 kph or ± 3 mph tolerance.

- (3) **Start/Course Speed.**

(a) The requested towboat start and course speed shall be given in units of whole kph or one-half mph with a tolerance of ± 1 kph or $\pm \frac{1}{2}$ mph and shall be limited by the maximum speed attainable by the towboat.

(b) The skier is permitted to request a differing starting speed and course speed.

(c) On achieving "course speed," the driver shall notify the boat judge(s) by calling "speed on."

Note: Course speed is defined in 102.

- (4) **Request Speed Signal.** The skier may request a signal when the requested start and/or course speed is attained. This signal may be requested in the form of sound, a hand signal or a tap/chop on the rope.

- (5) **Raise Engine.** The Skier can request the Driver to raise the engine from the default position and is responsible to approve its placement before commencing.

Note: If the skier requests the engine to be trimmed for higher speed, engine position shall never be grounds for a re-ride or protest [906(J)].

- (6) **Start Trick.** The start trick that the skier proposes to perform from any start trick listed in 1603(A).

- (7) **Preparatory Tricks.** All preparatory tricks shall be declared. These include but are not limited to: a turn to reverse direction after the start; toeholds in preparation for a toehold turn; lifting a foot to test whether the towboat is up-to-speed or to prepare for a one-foot turn.

Note: The action of changing the grip or how the handle is held in preparation for commencing a trick (e.g. taking the handle between the legs in preparation for line position tricks, holding the handle by the toe strap in preparation for neck or teeth tricks) shall never be considered a 'first movement' towards a trick. However, it is strongly advised that the skier advise the towboat crew of any such actions so as to avoid premature starting of the 15-second timer.

- (D) **Starting from Rest.** When preparing to start from rest, after the 10-second call from the towboat the skier shall communicate with the towboat only with the words 'IN GEAR,' 'STOP' or 'OK.' The towboat shall only proceed on the 'OK' command.

Note: No misunderstanding due to a departure from this standard phraseology may be accepted as grounds for a re-ride or protest [906B)].

(E) **Stop Command.** For safety purposes and to ensure proper communication with the towboat, the 'STOP' command can be communicated to the towboat crew by raising one hand, thus visually as well as verbally communicating the command to the towboat crew.

106: TURN-AROUND TIMES

(A) **Set by Chief Judge.** The Chief Judge will set the turn-around time after considering the recommendation of the Tournament Director.

(B) **Responsibility of Driver.** Turn-around times between passes is the responsibility of the Driver as follows:

- (1) **Time Commences.** Time is to commence when the towboat or chase towboat arrives at the start area, whichever is later.
- (2) **Warning.** Warnings will be given at 30 seconds and 10 seconds. It shall not be grounds for extra time or a re-ride should the 30-second call be given late or not at all.
- (3) **Before Turn-Around Time Expires.** Except in jump, the skier has the option to go before the turn-around time has expired.

Note: If the water has not settled in this shorter time, it will not be grounds for a re-ride [906(C)].

(C) **Flying Start.** The following procedure shall be followed for a dock start:

- (1) **Remain at Starting Dock.** The towboat shall remain at and in communication with the starting dock after having passed the handle to the skier.
- (2) **In Gear.** At the 10-second call, the towboat shall go into and remain in gear and shall move slowly away from the dock at idle speed.
- (3) **Idle Speed.** The towboat shall remain in gear at idle or the requested speed if above idle until the 'OK' or 'STOP' command is received from the skier.

(4) **Failure to Give 'OK' Command.** If the skier fails to give the "OK" command for the towboat to accelerate, the towboat shall at idle, even if this will result in pulling the skier off the dock. Under no circumstances is the towboat to accelerate away without having received a clear audible command from the skier. It is better to give a re-ride for a misunderstanding than risk injury to an unready skier.

108: EMERGENCY MINUTE

(A) **One Minute.** The Communication Boat Judge shall grant up to 1 minute for gear changes or equipment emergencies to replace broken or damaged equipment developing or discovered just prior to the skier's pass.

(B) **First Pass.** If at the expiration of the emergency minute the skier is not ready to start the pass, the skier shall be disqualified for 'failure to go' in accordance with 313(E). The disqualification of a skier for 'failure to go' shall be treated as an emergency for next skier and he shall be granted one emergency minute to prepare. An additional emergency minute shall be granted for each skier in turn that is disqualified.

(C) **Second Pass.** Should an emergency develop with skier equipment during or after the first pass, the skier is permitted to return to the starting dock in the towboat to use the emergency minute to obtain replacement equipment.

(1) The emergency minute is not permitted to retrieve equipment forgotten on the starting dock or other location.

Note: It is the skier's responsibility to ensure that any equipment required by the skier is placed in the towboat prior to the first pass [1601(C)].

(2) The emergency minute shall start when the skier gets on the starting dock.

(3) If at the expiration of the emergency minute the skier is not ready to enter the towboat from the starting dock, the skier shall forfeit his second pass.

CHAPTER 2: GENERAL REQUIREMENTS

201: APPLICATION

The rules set forth herein govern barefoot tournaments sanctioned by the IWWF. With the exception of entry requirements and other administrative matters, the Confederations shall follow these rules for their homologated tournaments. It is requested that Federations establish rules as close to these rules as possible.

202: SCHEDULING

The World Barefoot Waterski Championships shall be held biennially in even-numbered years and shall be comprised of three Championships with the Open, Junior and Senior World Barefoot Waterski Championships being held concurrently.

203: EXCEPTIONS TO THE RULES

Where compliance with the rules is not feasible, the Chief Judge must, with the approval of a simple majority of the Appointed Judges, make the necessary change, inform each skier by posting, and send a report to the WBC. Where the rules are definite and feasible, a vote of the Appointed Judges to decide whether to enforce any provision is prohibited.

204: INTERPRETATION OF THE RULES

- (A) **Questions.** Questions of interpretation of the rules shall be referred to the WBC when possible. All interpretations approved by the WBC shall be published in the Procedures, Policies and Guidelines (PPG) and are final.
- (B) **Simple Majority.** If an interpretation from the WBC is not possible and an interpretation is not contained in the PPG, an interpretation shall be made by a simple majority vote of the Appointed Judges, and the Chief Judge shall make a report to the WBC concerning the question.

205: RULES REVISION

It is the policy of the WBC to review the rules annually and publish the revised rules (if any) on 1 January of each calendar year. The WBC shall also review the rules at all meetings of the Council. The new rules shall become effective when the WBC publishes them on the WBC approved Internet site at www.WorldBarefootCouncil.com.

206: AMENDMENTS TO THE RULES

- (A) **Current Rulebook.** Until such time as a new edition of the Technical Rules is published, the current Technical Rules as published by the WBC shall remain in effect.
- (B) **Extraordinary Circumstances.** In extraordinary circumstances, the WBC is permitted to amend the rulebook at any time. Rule amendments made prior to the next January 1st publication of the rulebook shall be approved by a minimum of seven of the nine voting members of the WBC and are immediately applicable.

Note: This rule does not apply to the introduction of new tricks [1624].

207: RULE CHANGE PROCEDURE

- (A) **How to Submit.** Any member in good standing of a federation with competitive barefoot skiers can submit a proposal to add, edit or delete a requirement of the Technical Rules.
- (B) **Proposal Content.** The proposal must contain the following:
 - (1) Identify the Rule number to be revised where applicable.
 - (2) The text requested to be added, deleted, or revised.
 - (3) The reason for the rule change.

Note: Contact information for the WBC Rules Committee is available at www.WorldBarefootCouncil.com.

- (C) **Approval.** The proposed change will be reviewed by the WBC Rules Committee and any proposed changes shall be sent to the WBC for approval.
- (D) **Published on WBC Internet Site.** Any amendments shall be published as soon as practicable on the official WBC internet site at www.WorldBarefootCouncil.com.

208: VALIDITY

The inability of a country to attend the World Barefoot Waterski Championships for any reason does not require that the Championships be cancelled or postponed or that the Championships are any the less World Championships.

209: VOTING

Every vote shall be decided by a simple majority of the Judges voting. In the event of a tie, the Chief Judge shall cast the deciding vote.

210: SITE CLOSURE AND SET UP

The tournament site shall be declared closed at midday on the day prior to the start of the tournament. At that time the towboats, courses and all associated equipment shall be available for homologation.

CHAPTER 3: DIVISIONS AND EVENTS

301: DIVISIONS OF COMPETITION

- (A) **Divisions.** Competition in each event shall be separated into a Boys, Men and Gentlemen division for male skiers and Girls, Women and Ladies division for female skiers in accordance with 401.
- (B) **Dual Entry.** Skiers that fulfill the requirements of 401(A) or 401(C) are permitted to be entered by their Federation in both the Open and the Junior or Senior World Championships.

302: EVENTS

The events in a barefoot tournament are Jump, Slalom and Tricks for all divisions. A champion and succeeding places shall be determined for each event and for the Overall in each division, and for the Federation Teams as described in Chapter 5.

303: EVENT ROUNDS

- (A) **Three Rounds.** Each event shall consist of three rounds: an elimination round, a semifinal round and a final round.
- (B) **Tie Breaking.** A run-off to break a tie shall never be considered a round of competition and scores obtained from tie run-offs shall only be used for the purpose of breaking a tie. Run-off scores are not valid for overall scores, a ranking list score or a record.

304: SCHEDULE OF EVENTS

- (A) **Setting up and Announcement of the Schedule.**
 - (1) **Proposed Schedule.** Not later than 60 days before the start of the tournament, the Tournament Chairman shall send a proposed schedule of events to the Chairman of the WBC. Upon approval by the Council, the Tournament Chairman shall disseminate the approved schedule to each affiliated Federation.

- (2) **Starting Times.** Two days prior to the start of the tournament, the Tournament Chairman and the Chief Judge shall set starting times for each day.
- (3) **Guidance Only.** A schedule of starting times for individual events shall be for the guidance of the skiers, and any time deviation shall not constitute a change in schedule.

(B) Schedule Changes.

- (1) **Necessary Changes.** The Chief Judge shall make changes in the schedule during the tournament only for weather, water conditions, safety or a similar reason.
 - (a) All affected skiers shall be notified by posting **on the official notice board.**
 - (b) Although changes are to be discouraged, the Chief Judge shall not hesitate to make changes dictated by safety.
- (2) **Television Coverage.** Taking account of the importance of television, the Chief Judge is also authorized to make changes designed to increase or improve the coverage.

305: SITE FAMILIARIZATION

(A) Time Allocated.

- (1) **Team Skiers.** The LOC is required to ensure that, if requested, each team be allocated, free of charge, an elapsed period between leaving and returning to the dock equal to 8 minutes multiplied by the number of skiers in the team. The division of this time among the team members is the responsibility of the team representative.

- (2) **Independent Skiers.** An independent skier shall be given 3 minutes free of charge familiarization time for each event in which he is entered, up to a maximum of 8 minutes. Familiarization for independents shall be scheduled as close to their Federation's team scheduled familiarization time as practical. The LOC shall schedule independents with no Federation team present wherever expedient.

- (B) **Starting Order.** The starting order in familiarization shall, as far as practicable, be in the order of distance traveled from home base, e.g., the further the travel the later the turn.

Note: See PPG for specific site familiarization procedures.

306: DRIVER FAMILIARIZATION

Prior to the start of the tournament the Boat Drivers shall familiarize themselves with the tournament towboats, courses, rates of acceleration, top speed, underwater obstructions, etc.

307: THE DRAW

- (A) **Seeding Scores.** The World Scoring Program (WSP) rankings database shall be used to generate each skier's seed score as follows:

- (1) Current WSP ranking based on a 12 month period ending 4 weeks prior to the start of competition.
- (2) Skiers without current WSP ranking shall use a score from a 24 month period ending 4 weeks prior to the start of competition.
- (3) Skiers with no WSP ranking within 24 month prior to the start of the competition shall be grouped with the lowest seed group after all skiers with WSP seed scores.

- (B) **Group Divisions.** Skiers are divided into groups according to their seeding scores of approximately 15 for men and 10 for women.

308: STARTING ORDER

- (A) **Elimination.** Before the start of the first elimination round, the entry list shall be closed and thereafter the skier starting order **for each group as per 307(B) shall be in the reverse order of their placement in the seed rating scores as per 307 (A);** and such starting order shall be posted.
- (B) **Semifinal.** In the semifinal round of an event, the starting order of the semifinalists shall be in the reverse order of their placement in the elimination round of that event.
- (C) **Final.** In the final round of an event, the starting order of the finalists shall be in the reverse order of their best score from either the semifinal or the elimination round of that event.
- (D) **Change of Order.** Only the Chief Judge may change the skier starting order, except that a team representative may:
- (1) Withdraw a skier from the competition.
 - (2) Replace, with the authority of the Chief Judge, an injured skier with a qualified reserve from the same team as per 401(D).

- (E) **Ties.** Any ties in starting order placement shall be broken by the flip of a coin.

309: SEMIFINALS

- (A) **Positive Score Required.** To be eligible for the semifinals, a skier shall have a positive score in the elimination round of that event.
- (B) **Team Skiers.** The number of team skiers qualifying to go into the semifinals (N) is determined as follows:
- (1) N is a number between 8 and 12 inclusive.
 - (2) **Less than 9 Team Skiers.** If there are less than 9 eligible team skiers, all go into the semifinal.
 - (3) **Less than 17 Team Skiers.** If there are less than 17 eligible team skiers, N is equal to 8, or the number of eligible team skiers if less than 8.
 - (4) **17 or 18 Team Skiers.** If there are 17 or 18 eligible team skiers, N is equal to 9.

- (5) **19 or 20 Team Skiers.** If there are 19 or 20 eligible team skiers, N is equal to 10.
- (6) **21 or 22 Team Skiers.** If there are 21 or 22 eligible team skiers, N is equal to 11.
- (7) **More than 22 Team Skiers.** If there are more than 22 eligible team skiers, N is equal to 12.
- (C) Ties Between Team Skiers.** If there is a tie between team skiers for their Nth place, the following shall apply:
- (1) **Two Skiers.** If there are two team skiers in the tie, then both go into the semifinal round.
- (2) **More than Two Skiers.** If there are more than two team skiers in the tie then the Chief Judge shall decide whether to:
- (a) Have all of the tied team skiers in the semifinals.
- (b) Have none of the tied team skiers in the semifinals.
- (D) Independent Skiers.** In addition to the N team skiers, all independent skiers placed above the first N team skiers on the elimination results list shall qualify to go into the semifinals.
- (E) Nth Place Tie.** If there is a tie for Nth place between team and independent skiers, the Chief Judge shall decide whether to allow all or none of the Nth placed independent skiers to go into the semifinals. No tied independent skier shall go into the semifinals unless all tied team skiers in that division go into the semifinals.
- (B) Who Qualifies.** The first three skiers, based on the results of the semifinal round, shall be qualified to ski in the final round of that event. When the top three skiers from the semifinals have been selected, all their scores shall be removed from a copy of the combined results list of the first two rounds of the event. The skiers having the two top remaining scores on the combined event results list shall go into the finals. Thus the final round of an event will always comprise five skiers, unless fewer make a positive score in the elimination round or a qualified skier is unable to compete due to illness, injury or other reason.
- Note: A skier is not required to ski in the semi-finals to be eligible to ski in the finals.*
- (C) Last Qualifier Tie.** Ties for last qualifying place as per 310(B) shall be broken as follows:
- (1) **Jump.** Each tied skier shall be allowed three jumps to break the tie. This run-off shall proceed until the tie has been broken. The running order shall be determined by the flip of a coin.
- (2) **Slalom.** Each tied skier shall be allowed two passes to break the tie and this run-off shall proceed until the tie has been broken. The running order shall be determined by the flip of a coin.
- (3) **Tricks.** Each tied skier shall be allowed two passes to break the tie and this run-off shall proceed until the tie has been broken. The running order shall be determined by the flip of a coin.

310: FINALS

- (A) Positive Score.** To be eligible for the final, a skier shall have a positive score in the elimination round of that event. No distinction shall be made between team and independent skiers when deciding who goes into the finals.

311: COMPLETION

Once a tournament has started the Chief Judge does not have the authority to cancel any event and the tournament shall be completed, even if obliged to continue in another community, unless the WBC decides otherwise on the recommendation of the Chief Judge.

312: INTERRUPTIONS AND STOPPAGE

- (A) Interruptions.** In the case of an interruption of the tournament, the tournament shall be restarted as soon as possible without delay.

(B) Stoppage. In the case of a stoppage, the tournament restart shall be announced 10 minutes ahead of time.

313: DISQUALIFICATION

(A) Safety Compliance. Failure of a skier to wear a wet suit or helmet when required shall be cause of immediate disqualification from the event by the Safety Director.

(B) Danger to Himself. No skier shall be allowed to compete or continue to compete if, in the opinion of the Chief Judge, Safety Director and a simple majority of the Event Judges, his competing would be a danger to himself or to other skiers in the tournament. Whenever practical the advice of a doctor shall be obtained.

(C) Unsportsmanlike Conduct. A skier shall be disqualified by a simple majority vote of the Appointed Officials due to actions of a skier's parent or skier's representative, who may be charged with unsportsmanlike conduct because of extended or unwarranted harassment of an official on behalf of the skier.

(D) Detrimental to the Sport. A skier may be disqualified by a simple majority vote of the Appointed Officials due to actions considered detrimental to the Organizers or actions considered detrimental to the sport of barefoot water skiing.

(E) Not Ready at Starting Dock. Once the starting order is posted, it's the responsibility of the skier to be present at the starting dock in time for his turn. Any skier who fails to be on immediate hand and in condition to ski when the towboat is ready for him shall be disqualified for the event.

Note: The disqualification is treated as an emergency for the skier next in turn and he shall be granted one emergency minute in accordance with 108(B).

(F) Not Ready for Second Pass. The skier shall indicate his readiness to go after the 10-second call by the Boat Judges. Where a skier fails to indicate his readiness to go by the expiry of the 10 seconds, the Communicator Judge shall call 'TIME' and raise his hand to indicate the expiration of time. Should the skier not immediately signal the towboat to go via the "OK" command, the Communicator Judge shall advise the skier that he has been disqualified for the second pass.

CHAPTER 4: WORLD CHAMPIONSHIP ENTRY REQUIREMENTS

401: TEAM COMPOSITION

- (A) **Junior Team (Boys/Girls).** Each Federation affiliated to the IWWF shall have the right to select a team comprised of four members with a maximum of three of any one sex, to represent it in the Junior World Barefoot Championships. The competitor shall be under 17 years of age at midnight on December 31st of the year preceding the year of the Championships. Entries of teams and independents shall be accompanied by proof of age.
- (B) **Open Team (Men/Women).** Each Federation affiliated to the IWWF shall have the right to select a team comprised of six members with a maximum of five of any one sex, to represent it in the Open World Barefoot Championships.
- (C) **Senior Team (Gentlemen/Ladies).** Each Federation affiliated to the IWWF shall have the right to select a team comprised of four members with a maximum of three of any one sex, to represent it in the Senior World Barefoot Championships. The competitor shall be 35 years of age or older at midnight on December 31st of the year preceding the year of the Championships. Entries of teams and independents shall be accompanied by proof of age.
- (D) **Reserve Skiers.** Each Federation shall furthermore have the right to nominate two reserve skiers to each team to replace any injured skier.
- (1) A reserve skier shall take part only in those events of which the elimination round has not yet started at the time the replacement is made.
 - (2) The reserve skiers, if not called upon to replace an injured skier, shall have the right to ski as independents if so qualified.
 - (3) Reserve skiers replacing skiers of the opposite sex shall not participate in any event in which the elimination round for the injured skier has started at the time the replacement is made, e.g. a male reserve who is replacing an injured female skier shall not ski in a male jump if the female jump elimination round has already started.
 - (4) Any scores posted by a reserve skier while skiing as an independent shall never count toward Team Overall calculations.
- (E) **Team Representative.** Each team shall select a representative whose name shall be given to the Chief Judge before the start of the tournament.
- (F) **Independent Representative.** Federations shall select a representative whose name shall be given to the Chief Judge before the start of the tournament.

402: NATIONALITY

Each Federation shall certify to the WBC that all team and independent skiers meet all of the following qualifications:

- (A) **Citizenship/Residency.** A Federation may select its team in any manner it desires; however, each team member shall be a citizen, applying for citizenship, or prove residence in that country for at least five years with membership of an affiliated club or Federation. In case of doubt as to the nationality of a competitor, the WBC normally will refer to his passport.
- (B) **Federation Approved.** A Federation shall not select a person for its team who has represented another Federation in a World or Confederation titled event in the past two years, unless the former Federation agreed to the transfer, in which case the period of two years is reduced to 12 months.
- (C) **Membership.** Each competitor shall be a member in good standing of that Federation.

403: JUMP PROFICIENCY

Skiers entering the jump event must have achieved one of the following proficiencies:

- (1) A positive jump score on the current Rankings List.
- (2) A positive jump score in an IWWF Homologated Rankings List tournament between the cut off of the current Rankings List and up to four weeks prior to the World Championships.

Note: No skier will be allowed to compete or continue to compete if, in the opinion of the Chief Judge, Safety Director and a simple majority of the Event Judges, his competing would be a danger to himself or to other skiers in the tournament [313(B)].

404: CERTIFICATION

- (A) **Certification of Rating Score.** Rating scores shall be certified under the responsibility of the Chairman of the Barefoot Council of the skier's Confederation, based on performance in homologated competitions.
- (B) **Ranking List.** Rating scores shall be obtained in Ranking List tournaments within the period from the 1st January the year preceding the Championships up to five days before the start of the first competition event of the Championships.
- (C) **Without Further Examination.** The Tournament Chairman, without further examination, shall accept rating scores so certified.

405: ENTRY REGISTRATION

(A) Intent to Compete

- (1) **Eight Weeks.** Not later than eight weeks before the scheduled start of the tournament, each Federation intending to field a team **and/or Independents** in the World Barefoot Waterski Championships shall certify to the Chairman of the WBC and to the Organizing Committee its intent to compete **and their estimated entries** on the Intent to Enter Form.

Note: See PPG for 'Intent to Enter Form.'

- (2) **Late Fee.** Any Federation not meeting this requirement shall not be allowed to compete until they pay a fine of \$200 (USD) to the World Barefoot Council.

(B) Definitive Entry

- (1) **Team Skiers.** Not later than four weeks before the scheduled start of the tournament, each Federation intending to enter a team shall certify to the Chairman of the WBC, the Chairman of the Confederation Barefoot Council and the Organizing Committee, the names of the skiers (Maximum of eight for Open, six for Junior, and six for Senior) from which its team will be chosen, and the events each will enter on the Preliminary Entry Form.
- (2) **Independent Skiers.** At the same time as it enters these names it shall submit the names of any of its qualified independent skiers it wishes to enter, and the event or events they will enter on the Preliminary Entry Form.
- (3) **Late Fee.** Any Federation not meeting these requirements will not be allowed to compete until the Federation pays to the IWWF a fine of \$10 (USD) per skier per day after the four week deadline, for each skier not officially entered.

Note: See PPG for 'Definitive Entry Form.'

406: INDEPENDENT ENTRANTS

- (A) **Setting Qualification Scores.** Skiers not selected for their National teams may qualify to compete in the World Championships as independents. The WBC shall set qualifying scores for independents at least 15 months prior to the start of the World Championships and shall notify all federations at the time they are approved. This information will also be immediately available via the official WBC website, www.WorldBarefootCouncil.com.

Note: See PPG for guidelines.

- (B) **Previous World Champion.** All previous World Overall and World Event Champions, and all current World Record Holders, are eligible for entry to the World Barefoot Championships with the endorsement of their Federation without regard to 406(A). Event Champions can only enter those events in which they are previous World Champions. This rule does not qualify Junior or Senior Champions to compete in the Open Championships.
- (C) **Federation Entry.** Their Federation shall enter all skiers qualified as independents.
- (D) **Overall Points.** Skiers entered as independents shall be awarded overall points for the events in which they qualify.
- (E) **Team Overall.** Independent skier's overall scores shall not affect team overall scores.

CHAPTER 5: EVENT, OVERALL AND TEAM RANKING

501: EVENT PLACING

- (A) **Placement.** Event placing shall be based on the final round, followed by the semifinal round and elimination round results.
- (B) **Medal Round.** If no final round can be held due to force majeure, then the final medal placement of skiers shall be determined by using the best score registered by each skier in either the elimination round or semifinal round of the event.

502: CHAMPIONS

All divisions shall have champions in Jump, Slalom and Tricks, and an Overall Champion. There will be no event champion in events in which there are less than three competitors.

503: TIES

- (A) **Gold Medal Tie.** If there is a tie for the gold medal in any event the following rules shall apply:

- (1) **Jump.** A run-off of three jumps per skier between the tied skiers shall be used to break the tie. This run-off shall proceed until the tie has been broken. The order of skiing shall be determined by the flip of a coin. The skier posting the highest score in the run-off shall be declared the event champion, and the skier posting the lower score shall be the silver medalist.
- (2) **Slalom.** A run-off of two passes per skier between the tied skiers shall be used to break the tie. This run-off shall proceed until the tie has been broken. The order of skiing shall be determined by the flip of a coin. The skier posting the highest score in the run-off shall be declared the event champion, and the skier posting the lower score shall be the silver medalist.

- (3) **Tricks.** A run-off of two passes per skier between the tied skiers shall be used to break the tie. This run-off shall proceed until the tie has been broken. The order of skiing shall be determined by the flip of a coin. The skier posting the highest score in the run-off shall be declared the event champion, and the skier posting the lower score shall be the silver medalist.

- (4) **Run-off Not Possible.**

- (a) **Jump.** Should a run-off not be possible due to weather, force majeure, or injury through no fault or action of the skier, then the longest jump attained by a tied skier from any round of the competition shall be declared the event champion and the other tied skier shall be declared the silver medalist. Should the skiers still be tied, then the second longest jump attained by a tied skier from any round of the competition shall be declared the event champion and the other tied skier shall be declared the silver medalist.

- (b) **Slalom or Tricks.** Should a run-off not be possible due to weather, force majeure, or injury through no fault or action of the skier, then the highest score attained by a tied skier from any round of the competition shall be declared the event champion and the other tied skier shall be declared the silver medalist. Should the skiers still be tied, then the second highest score attained by a tied skier from any round of the competition shall be declared the event champion and the other tied skier shall be declared the silver medalist.

- (B) **Silver Medal Tie.** In the event of a tie for the silver medal, all tied skiers shall be awarded a medal **and there shall be no bronze medal award.**

- (C) **Bronze Medal Tie.** In the event of a tie for the bronze medal, all tied skiers shall be awarded a medal.

504: OVERALL SCORING—APPLICATION

(A) Team Overall Points. Team overalls are based on scores made by team skiers in the elimination and semifinal rounds, as they stand before the final round commences.

- (1) Team Overall points are used to calculate the team results only.
- (2) Team Overall points are definitive for team results.

Note: Team scoring requirements are contained in 508.

(B) Individual Overall. Individual Overalls are based on scores made by all skiers, including independent skiers, in all rounds and are used to calculate the individual event overall rankings. Individual Overall points are used for all divisions, and thus determine the Individual Overall Champions and succeeding places. They shall not be used to change the team rankings.

505: OVERALL SCORING—CALCULATION

(A) Team Overall Points. The best score by any team skier in either the elimination or the semifinal round of an event shall be awarded 1000 Team Final Overall points and shall be used to calculate the Team Overall points for all team skiers.

(B) Team Skiers Overall Points. All other performances by team skiers in those rounds shall be calculated according to the following formula, where the term 'top performance' refers to the best score by a team skier in either the elimination or the semifinal round of the event.

$$\text{Team Skier's Overall} = \frac{\text{Team skier's best score} \times 1000}{\text{Top performance}}$$

(C) Rounding. Event and Overall scores shall be rounded to two decimal places.

(D) Individual. The best score by any skier, including independent skiers, in any round of an event shall be awarded 1000 Individual Overall points and shall be used to calculate the Individual Overall points for all skiers. Scores obtained in running off a tie shall not be taken into account in the overalls.

(E) Individual Overall Points. All other performances by skiers in all rounds shall be calculated according to the following formula, where the term 'top performance' refers to the best score by any skier in any round of the event.

$$\text{Individual Overall Points} = \frac{\text{Skier's best score} \times 1000}{\text{Top performance}}$$

506: QUALIFICATION FOR OVERALLS

To be considered for overall placing, a skier shall post a positive score in at least one event.

507: OVERALL PLACING

Places in the Overall Championship shall be determined by totaling each skier's overall points as detailed in 505.

508: TEAM PLACING**(A) Open Team**

- (1) In Open Team scoring the best three overall scores per team, men and/or women, in each event, as detailed in 505(E), shall be totaled to obtain the team score.
- (2) The three skiers whose results are used for a team score may differ from event to event.
- (3) The skiers whose scores are used in team scoring shall be identified on the team **results**.

(B) Junior Team

- (1) In Junior Team scoring, the best two overall scores per team, boy and/or girl, in each event, as detailed in 505(E) shall be summed to obtain the team score.
- (2) The two skiers whose results are used for a team score may differ from event to event.
- (3) The skiers whose scores are used in team scoring shall be identified on the team **results**.

(C) Senior Team.

- (1) In Senior Team scoring, the best two overall scores per team, gentleman and/or lady, in each event, as detailed in 505(E) shall be summed to obtain the team score.

- (2) The two skiers whose results are used for a team score may differ from event to event.
- (3) The skiers whose scores are used in team scoring shall be identified on the team **results**.

509: RESULTS POSTING

- (A) **As Soon as Possible.** Results shall be posted as soon as reasonably possible after the conclusion of the event. If the results are not available 30 minutes after the last skier of the day the official posting will be delayed (except after the last final) until 30 minutes after the start of the next day's competition proceedings.
- (B) **Time of Posting.** The time of posting is the time the Chief Judge writes on the sheet as the time of signing the results.

510: SCORE SHEETS

- (A) **Available to Team Representative.** As soon as the results are posted the scoring sheets for all skiers shall be made available to the team representatives for inspection.
- (B) **Available Period.** For a period of 10 minutes after posting, team representatives may only view their own team's score sheets.
- (C) **Skier Access.** Under the team representative's responsibility, the skier may view his own scoring sheets.
- (D) **Viewing Area.** Score sheets shall not be removed from the designated viewing area.

CHAPTER 6: OFFICIALS

601: CHIEF OFFICIALS

- (A) **Nomination Deadline.** No later than nine months prior to the World Championships, Confederations shall submit nominations in the form of a resume to the Secretary of the WBC for the positions of Chief Judge, Assistant Chief Judge, Chief Scorer, Chief Driver, Chief Video Operator and Homologator.
- (B) **WBC Approval Deadline.** No later than eight months before the World Championships, the WBC shall make their recommendation for appointments by simple majority vote. The Chairman of the WBC shall then submit the recommended nominations to the President of the IWWF.
- (C) **Appointment by IWWF Deadline.** No later than seven months before the World Championships, and on the recommendation of the WBC, the President of the IWWF shall appoint the above-mentioned positions for the World Championships.
- (D) **Different Confederations.** The Chief Judge, Assistant Chief Judge and Chief Scorer shall be from different Confederations whenever possible.

602: APPOINTED JUDGES, SCORERS AND DRIVERS

- (A) **Nominations.** Confederations shall submit nominations in the form of a resume for the above-mentioned positions to the Secretary of the WBC no later than eight months prior to the World Championships.
- (B) **Chief Driver.** The Chief Driver shall be in addition to the three Drivers appointed from each of the three Confederations.
- (C) **Approved by WBC.** No later than six months before the Championships the Judges, Scorers and Drivers for the World Championships shall be appointed by a simple majority vote the WBC from the lists submitted by the three Confederations.
- (D) **Notification of Appointment.** The IWWF President shall inform the Confederational Chairmen and the Appointed Officials of these appointments via E-mail within one week of the decision.

- (E) **Qualifications.** The Nominated Judges, Scorers and Drivers shall be Level 1.
- (F) **Representation.** Appointed Officials shall represent the Confederations as follows:
 - (1) **Multi-Lake Site.** At multi-lake sites, four Judges, one Scorer and one Driver shall represent each of the three Confederations.
 - (2) **Single-Lake Site.** At single-lake sites, three Judges, one Scorer and one Driver shall represent each of the three Confederations.
- (G) **Reserve.** Each Confederation may provide a Reserve from each category for replacement(s) as deemed necessary by the Chief Judge. The Reserve, if used, shall come from the Confederation where the vacancy is.
- (H) **Insufficient Quantity.** If there are not enough qualified officials available from any Confederation, the Chairman of the Council shall select additional officials from other Confederations.
- (I) **Supervision.** The Chief Judge shall select Event Judges and Assistants for each event and shall supervise all judging and scoring operations. The Chief Judge and the Assistant Chief Judge shall not serve in the towboat.
- (J) **Exclusion.** Officials appointed by the WBC, including the Safety Director and any other appointed personnel who have unequal access to video footage of the Championships, shall not be permitted to ski in the World Championships or World Games.

603: SECONDARY POSITIONS

- (A) **Secondary Positions.** Personnel to fill secondary positions shall be selected by the Chief Judge from other experienced Judges and officials in attendance.
- (B) **Announcer.** Announcers are appointed by the local organizing committee and are to serve under the authority of the Chief Judge.

- (C) **Secretary.** A Chief Judge's Secretary shall be appointed by the Organizers to provide administration support to the Chief Judge. The Secretary shall be computer literate, have high levels of administration skills and good local knowledge of the Organizer's personnel and facilities.

604: INDEPENDENCE

Where possible, Boat Judges shall be separated to ensure completely independent opinions. Until the expiry of the protest period the Boat Judges shall not confer on their score except to determine the last trick in time [1607(D)] or to provide provisional results [909].

605: REPLACING OFFICIALS

The Chief Judge is permitted to replace Event Judges and Drivers during an event at his discretion. Such change-over shall take place between groups.

606: AFFIDAVIT

The Chief Judge and each Appointed Official shall sign a statement on the prescribed form at the conclusion of the tournament that the rules were followed implicitly, noting any exceptions allowed.

607: MINIMUM REQUIREMENTS FOR BOAT OFFICIALS

- (A) **Ranking List (RL) Tournament.** Two Level 3 and one Level 4 Judge, or a single Level 1 or Level 2 Judge shall be in the towboat.
- (B) **Record Capability (RC) Tournament.** One Level 2, one Level 3, and one Level 4 Judge, or a single Level 1 or Level 2 Judge shall be in the towboat.
- (C) **World Championships.** Three Level 1 Judges, or a single Level 1 Judge is permitted to replace the three Boat Judges in order to obtain and maintain a minimum of 72 kph/44.7mph through the course as required in 1101.

Note: See PPG for Levels of officials, experience, and qualifications requirements.

CHAPTER 7: VIDEO

701: APPOINTMENTS

The host Federation of a World Championship shall appoint three suitably experienced Video Operators who shall be responsible to the Chief Video Operator.

702: ASSIGNMENT

- (A) **Video Camera.** A video camera shall be used to make a permanent record of all events.
- (B) **Operator.** The video camera shall be operated by a Video Operator or be affixed to a solid mounting device in the towboat.

703: AVAILABILITY

- (A) **Official Assistance.** The video recording forms the official assistance to the Chief Judge, the Boat Judges, and the IWWF.
- (B) **Available to IWWF.** For this purpose, the copyright original or a good copy shall be made available on-site to the IWWF for internal use, free of charge.

704: MEDIA

The Chief Judge is permitted to allow an additional accredited camera operator to ride in the towboat for the purposes of the media.

705: BOAT LOADING

- (A) **Ballast Added.** Should a camera operator leave the towboat during an event, sufficient ballast shall be placed in the towboat for the remainder of the event to avoid a significant change to the towboat wake.

- (B) **Ballast Removed.** Should a camera operator board during an event, sufficient ballast shall be removed from the towboat for the remainder of the event to avoid a significant change to the towboat wake.

- (C) **Two Camera Operators.** Two camera operators authorized in 704 shall not be allowed to ride in the towboat at the same time if the towboat wake is adversely affected to a significant degree.

706: OFFICIAL USE

Note: See video review requirements outlined in PPG for specific video review procedures.

- (A) **When Permitted.** The Boat Judges are only permitted to view the official video of an event before the expiry of the protest time at the request of the Chief Judge or Chief Scorer, under the following circumstances:

- (1) **Simple Majority.** To obtain a simple majority decision as to the skier's performance.
- (2) **Failure of Timing Device.** To determine the time parameters of a pass in the event of failure of the timing device.
- (3) **Exceptional Circumstances.** In circumstances which are judged to be exceptional, the Chief Judge or Chief Scorer is authorized to instruct the Boat Judges to review the video recording to correct errors or misconceptions. The Chief Judge is free to use any and all evidence he feels is applicable to effect an expeditious and correct decision.

- (B) **Jump Event.** Boat Judges are permitted to review the official video immediately so as to ascertain the validity of the jump before the next jump is taken.

Note: See PPG for specific video review procedures.

CHAPTER 8: SAFETY

801: SAFETY DIRECTOR

- (A) **Appointment.** At least two months before the tournament, the Tournament Committee shall appoint a Safety Director, who will appoint such assistants as appear necessary.
- (B) **Responsibility.** The Safety Director shall be responsible for the safe condition of all equipment and facilities and the operation of the tournament, but this shall not prevent him from delegating specific responsibilities to assistants as approved by the Chief Judge.
- (C) **Proximity.** The Safety Director shall remain near the competition area as much as possible.
- (D) **Authority.** The Safety Director shall have the authority to take whatever action is necessary, including stopping the tournament, whenever he observes a condition he believes unsafe.
- (E) **Halt Tournament.** During the competition, the Safety Director is permitted to request the Chief Judge to halt the tournament for a poll of the Event Judges in regard to a skier's actions or condition.
- (F) **Overruled by Chief Judge.** The Chief Judge is authorized to overrule any contemplated action or decision of the Safety Director, but on his own responsibility.

802: FLOTATION AND PROTECTION

- (A) **Flotation.** A neoprene wet or dry suit meeting the following requirements shall be worn by all skiers in all events:
 - (1) Be smooth, soft, and free from attachments or material likely to cause injury in a fall.
 - (2) Be so constructed and fastened that it's unlikely to be torn loose or damaged so as to render it useless in a hard fall.
 - (3) Float the user.
 - (4) Not be an inflatable device.

- (5) Be constructed so as to provide adequate protection from impact damage to the ribs and internal organs.

- (B) **Suitability.** In case of doubt on the suitability of flotation, the Safety Director shall order a practical test in the water.

803: HELMETS

- (A) **Specification.** A skier in the jump event shall wear a helmet of a type designed to protect the head from severe impact injury.
- (B) **Radio Communications.** The use of helmets fitted with radio communication capabilities is prohibited in the jump event.

804: TEMPORARY INCAPACITATION

- (A) **Three Emergency Minutes.** At the discretion of the Boat Judges, the skier can be granted up to three minutes to recover from a heavy fall between passes, starting from either the time the towboat returns to pick him up or the pick-up boat arrives at the starting buoy. If the skier cannot recover from a heavy fall within those three minutes, he shall not be permitted to ski again in that round.
- (B) **Incapacitated Skier.** If the skier should become incapacitated through no fault or action of his own, the timing shall stop until the next round of competition of that event has started or it can be satisfied, where possible on medical advice, that he is sufficiently recovered to continue. In the meantime, the competition goes on with succeeding skiers.

805: SAFETY PERSONNEL

- (A) **Swimmer.** A swimmer who is familiar with all tournament events and practice and ideally is fully trained in First Aid, Emergency Resuscitation and Water Rescue Techniques shall be on-site at all times.

Note: See PPG for WBC Safety Manual.

- (B) **Floated to Shore.** Any skier that is unable to climb into a towboat unassisted shall be floated ashore and lifted from the water on a suitable board or stretcher.
- (C) **Into Towboat.** Under no circumstances will an injured skier be lifted passively over the side of a towboat.
- (D) **Life Jacket.** The swimmer shall wear a life jacket at all times and, in the event of a serious fall will jump into the water to assist the skier.

Note: Language difficulties may interfere with communication; and for this reason, the swimmer must get into the water to assist the injured skier.

806: ON-SITE MEDICAL FACILITIES

The Safety Director shall appoint a Tournament Medical Officer to provide the following services wherever possible:

- (A) **Medical Officer.** A suitably qualified Medical Officer will be in attendance during all tournament events.
- (B) **Medical Station.** A suitably equipped medical station prepared to deal with a medical emergency will be conveniently located at the tournament site.
- (C) **Transportation.** Suitable transportation to safely and promptly move an injured skier to a local medical unit for additional medical care.
- (D) **Prompt and Qualified Treatment.** A working relationship will be established between the local hospital or medical unit and the Tournament Medical Officer, such that casualties will get prompt and qualified treatment when required.

CHAPTER 9: RE-RIDES

901: WHEN A RE-RIDE IS GRANTED/REQUIRED

(A) Optional Re-Ride.

- (1) **Conditions or Malfunctions.** When water, weather or other conditions are substantially different from the other competitor's conditions, or in the event of a malfunction of the tournament-supplied equipment occurs that in the opinion of the simple majority of the Boat Judges unfairly affects a skier, he shall be granted the option of a re-ride only on the pass affected.
- (2) **Speed Tolerance.**
 - (a) **Jump Event.** When the speed varies by more than ± 1.5 kph/1 mph in the Jump event [1404(A)], the skier shall be offered an optional re-ride, except where mandatory re-ride is required in 901(B)(3).
 - (b) **Slalom/Trick Event.** When the speed varies by more than ± 1 kph or $\pm \frac{1}{2}$ mph for the Slalom event [1504(A)] or the Trick event [1604(A)], the skier shall be offered an optional re-ride.

(B) Mandatory Re-Ride.

- (1) **Unfair Advantage.** When it's the opinion of the simple majority of the Boat Judges that a malfunction or conditions give a skier an unfair advantage, the skier shall be required to take a re-ride on the pass affected.
- (2) **Start/End of Pass.** If the start or end of the pass cannot be determined by the combined use of the official video and the Boat Judges' sheets, then a re-ride is mandatory.
- (3) **Speed.** If the average speed through the jump course exceeds 73.5 kph/45.7 mph, then a re-ride is mandatory [1404(A)].

(C) **Scoring of Re-Ride.** When taken, a re-ride is scored and the pass for which the re-ride was given is annulled.

902: RE-RIDES IN THE JUMP EVENT

- (A) **Five-Minute Rest.** If more than one re-ride is given in any series, the skier shall have the option of a five-minute rest before recommencing his turn.
- (B) **Boat Path.** If the path of the towboat eventually differs by more than one-half of the gate width from that requested by the skier, the Boat Judge shall offer the skier an optional re-ride.
- (C) **Malfunction.** Should a malfunction of the jump measuring equipment render an otherwise valid jump to be unreadable, the skier shall be offered the choice of an optional re-ride or to accept the lowest distance readable on the screen, minus one-tenth meter.
- (D) **Immediately.** If a re-ride is granted in the jump event for other than temporary incapacitation, the re-ride shall be taken immediately.

Note: See 804 for temporary incapacitation requirements.

903: RE-RIDES IN THE SLALOM EVENT

If a re-ride is granted, the skier has the option of either a 5-minute rest period or to take the re-ride immediately. If the skier elects to take a 5-minute rest, the next skier in order shall ski, and the re-ride shall be taken at the conclusion of the skier's turn during which the 5-minute rest period expires.

904: RE-RIDES IN THE TRICK EVENT

- (A) **Rest Period.** If a re-ride is granted, the skier has the option of either a 5-minute rest period or to take the re-ride immediately. If the skier elects to take a 5-minute rest, the next skier in order shall ski, and the re-ride shall be taken at the conclusion of the skier's turn during which the 5-minute rest period expires.
- (B) **Start Trick.** In the event of a re-ride during the start trick portion of the pass, the skier shall have the option of:

- (1) **Repeat Start Trick Only.** Repeating the start trick while retaining the pass tricks scored during the affected pass, or:
 - (2) **Repeat Start and Trick Pass.** The entire pass for which the re-ride is given shall be annulled and scoring for the re-ride shall comprise the start trick and the pass tricks made in the 15 seconds of the re-ride pass.
- (C) Pass Trick.** In the event of a re-ride during the pass tricks portion of the pass:
- (1) **Annulled Pass.** The 15-second pass score of the affected pass shall be annulled.
 - (2) **Start Trick.** Any start trick on the affected pass, whether successful or unsuccessful, shall stand and be carried forward as the start trick score for the re-ride of that pass. On the re-ride, the skier is permitted to attain BSP by any start trick listed in 1603(A) that he chooses, but that start shall not count for scoring purposes.
 - (3) **Scoring.** Scoring for the re-ride shall comprise pass tricks made in the 15 seconds of the re-ride pass plus the start trick score carried forward from the affected pass.

905: RE-RIDE REQUEST

- (A) Initiated by Boat Judge or Driver.** Requests for re-rides shall be initiated by a Boat Judge or Driver before the next skier starts and shall be decided as soon as practicable thereafter. The video operator is permitted to offer information that may have escaped the notice of the Boat Judges.
- (B) Skier or Team Representative.** A skier or his Team Representative is not permitted to request a re-ride.
- (C) Skier May Draw Attention.** The Team Representative or skier is free to draw the attention of the Boat Judges to some relevant condition or circumstance affecting the granting of a re-ride that may have escaped their notice. The Boat Judges shall consider such submission and act on it or not as they see fit. The Boat Judges shall maintain the strictest vigilance to ensure the interests of the skier are fully respected.

- (D) Simple Majority.** The Boat Judges shall not proceed with the next pass unless a simple majority of them have indicated that nothing was wrong with the last pass, making an appropriate entry in the tick box on the score sheet.

906: NOT BASIS FOR A RE-RIDE

- (A) Top Speed Advisory.** Any top speed advisories given from the towboat during the competition shall be considered a courtesy and shall never be grounds for a re-ride or protest.
- (B) Starting From Rest.** The skier shall communicate with the towboat only with the words 'IN GEAR,' 'STOP' or 'OK.' The towboat shall only proceed on the 'OK' command. A misunderstanding due to a departure from this standard phraseology shall never be grounds for a re-ride or protest.
- (C) Before Turn-Around Time.** The skier has the option to go before the turn-around time has expired. If the water has not settled in this shorter time, it's the skier's own responsibility and shall never be grounds for a re-ride or protest.
- (D) Rope Position.** It is the skier's responsibility to ensure that the rope is at the proper height. Incorrect rope height shall never be grounds for a re-ride or protest.
- (E) Boat Speed.** The failure of the towboat to attain a speed greater than 72 kph/44.7 mph shall never be grounds for a re-ride or protest.
- (F) Last Trick In Time.** A mistake by the Boat Judges communicating the last trick in time shall never be cause for a re-ride or protest.
- (G) Provisional Score.** An error or misunderstanding on the part of the officials on communicating provisional scores shall never be grounds for a re-ride or protest.
- (H) Skier Lands Prior to or Past Landing Box.** A successful jump that is unreadable due to the skier landing prior to or past the video box shall never be grounds for a re-ride or protest.
- (I) Failure of Skier's Equipment.** A failure of skier's own equipment is the skier's responsibility and shall never be grounds for a re-ride or protest.

(J) Engine Position. If the skier requests the engine to be trimmed for higher speed, engine position shall never be grounds for a re-ride or protest.

907: SAME INSTRUCTIONS

In the case of a re-ride, the skier's instructions for the pass shall not differ from those given for the annulled pass.

Note: See 105 for skier instruction requirements.

908: REFUSAL TO ENTER COURSE

A competitor is permitted, for reasons acceptable to the Boat Judges, to refuse to enter the course in any event and shall do so by throwing the handle into the air.

Note: Re-rides are only given in accordance with the conditions specified in 901.

909: PROVISIONAL SCORES

In the event of an optional re-ride being offered, the skier has the option of requesting a provisional score from the Boat Judges before deciding to accept or decline the re-ride. This provisional score need not be communicated as total points, but may be communicated as tricks/crossings that were and were not credited or the provisional jump distance communicated from the Video Judges.

CHAPTER 10: PROTESTS

1001: PROCEDURE

(A) Submitted to the Chief Judge. Protests shall be filed by the Team representative to the Chief Judge in written form together with the required fee listed in 1004, and shall be voted on by the Event Judges.

(B) Requirements. Protests shall cite the rule number that applies, the reason for the protest, and it shall be filed within 30 minutes after the results of the event have been posted.

Note: Results are considered posted at the time the Chief Judge writes on the sheet as the time of signing [509(B)].

1002: BASIS

Protests shall only be permitted for the failure of an official or Tournament Committee to comply with the rules contained in this rulebook.

Note: Protests are not permitted on a judgment decision by the Boat Judges.

Necessary changes to the course due to safety issues encountered after the start of the tournament shall never be grounds for a protest.

1003: CHIEF JUDGE DECISION

The Chief Judge can, without precedent, overrule any decision made by the Event Judge(s) to resolve a protest providing the Chief Judge is cognizant of all the facts pertaining to the decision in question. Protests on these decisions are allowed and any decision thus taken by the Chief Judge shall only be overruled by a simple majority vote of all of the Appointed Officials.

1004: FEE

Protests shall be accompanied by the approximate equivalent in U.S. currency of \$10 (USD). This amount will be refunded if the protest is considered reasonable by the Event Judges, even if the protest is disallowed.

1005: CALCULATION ERROR

(A) Within Two Hours of Postings. A request for a correction of an error in the computation or input of a score within 2 hours of the posting of the event results by a Team Representative shall not be considered a protest and a correction shall be made with the approval of the Chief Judge and Chief Scorer.

(B) Within One-Half Hour of Next Round. A correction of an error in the computation or input of a score discovered by the Chief Judge or Chief Scorer may be corrected up to one-half hour before the start of the next round of that event.

(C) Semifinals. Any skier displaced from the semifinals resulting from a correction of an error in computation or input of a score shall go on to the next round.

(D) Finals. No more than five skiers shall be permitted to advance to the final round [309(B)], so any skier displaced resulting from a correction of an error in the computation or input of a score shall not go to the final round.

CHAPTER 11: TOWBOATS, ROPES, HANDLES, AND TIMERS

1101: BOAT SPECIFICATIONS

(A) Speed. Towboats containing the required boat officials as per 607 shall have the performance necessary to obtain 72 kph/44.7 mph by the skier's advisory buoy while towing a heavy barefoot skier weighing approximately 80k/175 lb.

- (1) **Lengthen Course Run-Up.** If necessary, the length of the run-up shall be adjusted, subject to the limits contained in 104(A4), to make the attainment of the required speed by the skier's advisory buoy possible.

Note: The distance between the starting dock and the turn-around buoy shall be not less than 650m and not more than 850m [104(B)].

- (2) **Full Throttle Acceptable.** In complying with this speed requirement, it's understood that full throttle may be used throughout the acceleration phase.

(B) Default Trim Position. Where trimming capability is fitted to the towboat, the Homologator shall set the trim for the required speed and optimum wake. This shall be the default position. It is the responsibility of the Driver to ensure the engine is at the default position before every skier.

(C) Size. Overall length shall be approximately 5m, but shall not exceed 7m and the beam shall be not less than 1.80m and not more than 2.50m.

(D) Points of Attachment. Towboats shall be equipped with towing attachment points on the centerline of the towboat with a minimum of two heights.

- (1) **Mandatory Lower Attachment Point.** When the towboat is standing still with no occupants aboard, the lower attachment point shall be a minimum of 65 cm and a maximum of 1.2m.

- (2) **Mandatory Middle Attachment Point.** When the towboat is standing still with no occupants aboard, the middle attachment point shall be a minimum of 2.0m and the maximum of 2.25m above the water.

- (3) **Optional High Attachment Point.** When the towboat is standing still with no occupants aboard, an optional attachment point shall be permitted to be located approximately 4.0m above the water.

(E) Speed-Measuring Devices. Towboats shall contain two accurate speed-measuring devices operating on separate pick-up tubes or transmitters. Both of these speed-measuring devices shall be visible to the Driver when facing forward. A third speed-measuring device shall be placed so that it's visible to the Boat Judges when facing aft.

(F) Tachometers. Towboats shall be equipped with tachometers.

(G) Speed Guarantee.

- (1) **Jump Event.** The requested speed up to 72 kph/44.7 mph shall be reached not later than when the towboat reaches the entry gates.

- (2) **Slalom and Tricks Event.** The requested speed up to 72 kph/44.7 mph shall be reached not later than when the towboat reaches the skier advisory buoy(s) unless the skier has persisted in the start, thus making the course speed unattainable using a fast pull after the start.

Note: The failure of the towboat to attain a speed above 72 kph/44.7 mph is not grounds for a re-ride or protest [906(E)].

1102: WORLD CHAMPIONSHIPS

- (A) **Towboat Approval.** The towboats to be used in the World Championships shall be approved by the WBC. Inboard, inboard-outboard or outboard power can be used. This information shall be provided to the Chairman of the Barefoot Council of each Confederation not less than six months before the tournament.
- (B) **Event Boat Selection.** The towboats to be used for each event shall be decided by the Organizers. If more than one type of towboat will be used, the information in 1102(A) shall include a list of the events scheduled for each towboat.
- (C) **Identical Boats.** Identical towboats shall be used for all contestants in a division for each event.

1103: ROPES AND HANDLES

- (A) **Notification.** Information of the type of rope and handles shall be provided to the WBC not less than six months before the tournament. If more than one type of rope and handle will be used, this information shall include a list of the events scheduled for each type of rope and handle.
- (B) **Tournament-Supplied.** There shall be sufficient quantities of tournament-supplied homologated ropes and handles so as to ensure for the smooth operation of the tournament.
- (C) **Handle.** Tournament-supplied handles shall meet the following requirements:
- (1) Flotation. Handles shall float or incorporate flotation.
 - (2) Grip. The handle grip shall be made of 25mm to 28mm outside diameter material with no sharp edges or projections, and with non-slip coating. Attaching ropes shall in all cases go through the handle grip and shall be attached so there is no possibility of movement between the rope and handle grip when in use.
 - (3) Loop. Handles shall be finished with minimum 15cm loop.
 - (4) Length. The handle and bridle shall have a length of 1.50m \pm 10cm
 - (5) Width

- (a) **Jump Handle.** A handle having a width of 30cm \pm 2.5cm, with a 30cm \pm 2.5cm length of attached ropes before juncture shall be in the towboat for the Jump and Slalom event, and it shall be the only handle used in the jump event.

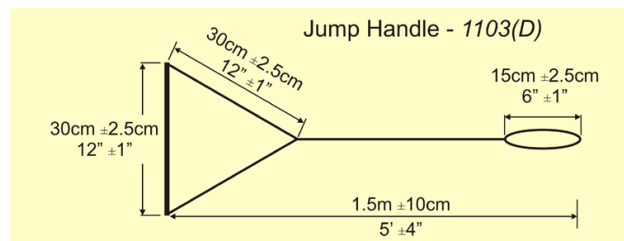

- (b) **Slalom Handle.** A handle having a width of 38cm \pm 2.5cm, with a 38cm \pm 2.5cm length of attached ropes before juncture shall be in the towboat for the Slalom and Trick event.

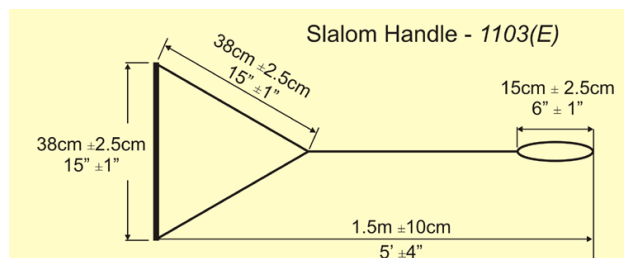

- (c) **Trick Handle.** The handle available in the trick event shall be the 38cm handle specified for slalom.
- (6) **Measurement.** Measurements of handles shall be made with 20 kg of tension and shall be between the center of the handle grip (or inside of rope loop) and the inside of the rope loop at the other end.
- (D) **Rope.** The Tournament Committee shall have at least one rope meeting the following requirements in the towboat for all events:
- (1) **Stretch.** Ropes shall be made from a low-stretch plastic or similar material and have been sufficiently pre-stretched so as to allow only minimal stretch.
 - (2) **Length.**
 - (a) **Rope.** The overall length of the tournament-supplied rope shall be 21.5m \pm 15 cm. between the inside of rope loops under 20 kg of tension.

- (b) **Rope and Handle.** The tournament-supplied rope length with the handle shall be 23m \pm 15cm between the center of the handle grip and the inside of the rope loop with 20 kg of tension.

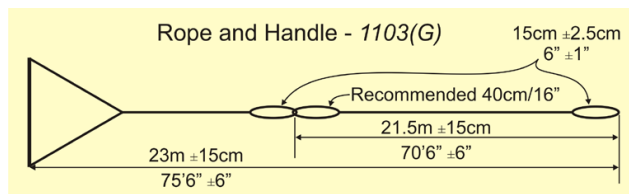

- (c) **Measurement.** Measurements of rope and handle shall be made with 20 kg of tension and shall be between the center of the handle grip (or inside of rope loop) and the inside of the rope loop at the other end.
- (3) **Loops.** The ends of the rope shall be finished with 15cm \pm 2.5cm loops.
- Note: It is recommended that the trailing end of the rope be finished with a 40cm loop or fitted with a lightweight clip for easy attachment of handles.*
- (4) **Clips.** Except in the jump event, lightweight clips for easy attachment of handles shall be permitted.
- (5) **Junctures.** Junctures in lines shall be by splicing or threading of adequate length to prevent slippage, and reinforced where necessary by knotting, stitching or binding.
- (6) **Leader.**

- (a) A two-meter leader meeting the specifications of 1103(D)(1) shall be attached to the optional high attachment point [1101(D)(3)] and shall be equipped with a light weight clip [1103(D)(4)] for the attachment of ropes during the trick and slalom events.

Note: The clip is not permitted to be used for the jump event [1103(D)(4)].

- (b) The overall length of the tournament supplied rope and leader, shall be 21.5m \pm 15 cm between the inside of rope loops under 20 kg of tension.

- (E) **Skier Supplied Rope and Handle.** For the trick event, the skier is permitted to furnish his own rope and handle of any size, length and material. Detachable handles shall be finished with a 40cm loop or fitted with a lightweight clip for easy attachment of handles.

Note: Failure of skier's own equipment shall never be grounds for a re-ride [906(I)].

1104: TIMERS

(A) Majority Timer

- (1) **Three Switches.** For timing the 15-second period in Slalom and Tricks, an automatic timing device giving an audible sound at the start and finish of pass shall be used. This timing device shall be provided with three operating switches, one for each of three Boat Judges.
- (2) **Each Judge.** Each Boat Judge shall operate his switch when he observes the start of pass as defined in 1505 and 1605.
- (3) **Two of Three Boat Judges.** The timing device shall be programmed to sound the signal and start the 15-second timing at the moment when two of the three Boat Judges have operated their starting switches. Thus, the first switch to be pressed in chronological order shall arm the device and thereafter the second to be pressed will activate it.

- (B) **Instantaneous Timer.** As an alternative, a timing device with a single operating switch shall be permitted. One of the Boat Judges shall be assigned to operate the timer switch when he observes the start of pass. In all other respects, the automatic timing device shall operate as in 1104(A).

CHAPTER 12: SPEED CHECKS

1201: METHOD

- (A) **Boat Speed Check.** Before each event and/or at the discretion of the Chief Judge, the towboat speed-measuring device shall be checked with a GPS speed-measurement device to obtain the correct boat speed under tournament conditions.
- (B) **Current or Stream.** If there is a current or stream, the times for each selected speed shall be recorded in both directions, up-and-downstream and the average speed (not time) used as the recorded speed.

1202: TOP SPEED ADVISORY

Before the start of the tournament the Chief Driver shall inform the Chief Judge of the top speed attained at the skier's advisory buoy for all towboats, and this information shall be supplied to the team representative before the start of the tournament.

Note: Speed attained is based on the towboats containing the required boat officials as per 607 while towing heavy barefoot skier weighing approximately 80k/175 lb [1101(A)].

CHAPTER 13: COMMUNICATIONS AND VIDEO EQUIPMENT

1301: COMMUNICATIONS

Efficient two-way radios shall be provided for the Chief Judge, Assistant Chief Judge, Chief Scorer, Safety Director, Tournament Director, and Boat Judges in towboats.

CHAPTER 14: JUMP EVENT

1401: JUMP RAMP

The jump ramp shall meet the following specifications:

- (A) **Height.** The height of the lip of the jump ramp shall be 45.5cm \pm 1.0cm above the waterline, measured on both sides and the overall length shall be approximately 4m.

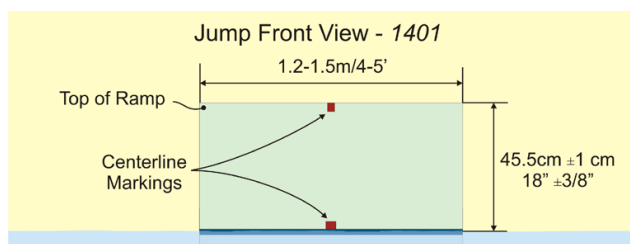

- (B) **Surface.** The surface of the ramp out of the water shall be 210cm \pm 4.2cm long, with the waterline marked by the center of a transverse line of contrasting color of a width equal to the total 8.4cm. The width of the ramp surface shall be a minimum of 1.20m and a maximum of 1.50m with parallel sides. The surface of the jump ramp shall be flat with a maximum deviation of \pm 1cm from a plane. The overall length of the ramp surface shall be approximately 4m.

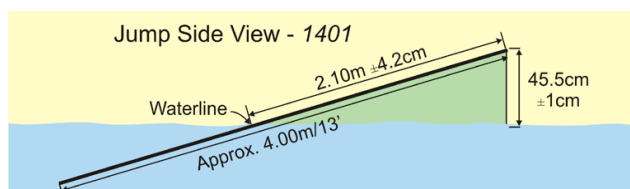
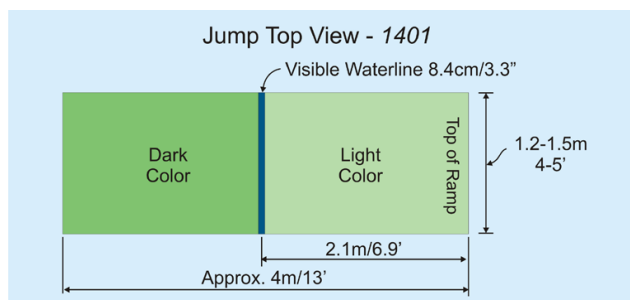

- (C) **Transverse Line Marking.** The centerline of the transverse line shall be marked at least at the edges of the ramp.

- (D) **Contrasting Color.** The submerged surface shall be of a dark color so as not to be visible to the skier. The exposed part above the waterline shall be of a light color.
- (E) **Strength and Stiffness.** The jump-ramp surface shall be the equivalent of 19mm marine plywood in strength and stiffness, suitably braced and with smooth integral or glued safe surfacing.
- (F) **Buoyancy.** Suitable buoyancy properly disposed shall be used to ensure stability and the dimensions set out in 1401(A) and (B).
- (G) **Center Lines.** Centerline markings of a strongly contrasting color shall be placed on the front face of the ramp at the waterline to facilitate measuring to the inner and outer course buoys.

1402: STARTING

The skier shall start by means of a deepwater start and shall pass the start-of-course buoy in forward BSP and maintain it to the ramp, both to be judged from the towboat.

1404: BOAT SPEED AND PATH

- (A) **Maximum Speed.** The requested **course** speed shall be at the option of the skier, up to a maximum of 72 kph/44.7 mph and shall be obtained not later than when the towboat reaches the jump course entry gates. This speed shall be maintained \pm 1.5 kph or \pm 1 mph tolerance through the end of course.
- (B) **Path Instructions**
- (1) **'Wide.'** The towboat passes as close to the outside buoys as feasible, but shall not go over the buoy.
 - (2) **'Split.'** The towboat passes halfway between the two buoys.
 - (3) **'Close.'** The towboat passes as close to the inside buoys as feasible but shall not go over the buoy.

- (C) **Boat Path.** The towboat shall follow a straight path, parallel to and on the left side of the ramp surface in accordance with the skier's instructions. The towboat path instruction applies equally to both the start-of-course and the ramp gates and shall be identical for both.

1405: START OF PASS—JUMP ATTEMPT

A skier is considered to have started the pass once he gives the 'OK' **command** to the Boat Judges in accordance with 105(D).

Note: Skier instructions for the Jump Event are described in 105(A).

1406: PASSES—JUMPS

- (A) **Number of Jumps.** In each round each skier shall be allowed three registered jumps.
- (B) **Exceptional Circumstances.** In exceptional circumstances the Chief Judge and the Appointed Judges are authorized to vote to reduce the number of jumps for a round to a minimum of two, and post a notification before the start of the round affected. In such a case the Chief Judge shall make a report to the WBC giving the reason(s) for the deviation.
- (C) **Skier Loses Helmet.** If a skier loses his helmet during the start or before reaching the jump ramp, the towboat shall immediately stop, unless it's unsafe to do so. Should it be unsafe for the towboat to stop, the skier shall ski past the jump whenever possible, and this jump shall be scored as a fall. These are not grounds for disqualification from the remainder of the event.

1407: OFFICIALS

- (A) **Boat Judge.** One Boat Judge shall ride in the towboat to observe boat path, course speed, the skier's performance in relation to maintaining BSP from start-of-course buoy, over the ramp, and regaining BSP after the landing before the end-of-course buoy, and Driver's compliance with the skier's instructions.
- (B) **Agreement.** By observing the speed measuring devices the Driver and Boat Judge shall both agree that the skier received their requested speed through the course.

- (C) **Speed Adjudicator.** A Speed Adjudicator shall also ride in the towboat to verify the boat speed via GPS. In the event of a disagreement between the Driver and Boat Judge, the speed recorded on the Speed Adjudicator's GPS shall be used.

- (D) **Electronic Timing.** Electronic timing devices approved by the WBC shall be used when available and the times/speeds ascertained from these devices shall be used as the primary means of determining the towboat speed through the course.

1408: CREDIT FOR JUMP

- (A) **Jump Scored.** All jumps not disallowed under rule 1408(B) shall be scored.

- (B) **Jump Disallowed.** A jump shall be disallowed if:

- (1) **BSP Prior to Ramp.** The skier does not attain BSP by the start-of-course buoy and maintain it to the ramp.
- (2) **Tumbleturn.** The skier attempts to recover by a greater than 90-degree tumbleturn after the skier has gone over the ramp, but before BSP has been recognized.
- (3) **BSP after Ramp.** The skier does not attain BSP before the end-of-course buoy.
- (4) **Maximum Speed.** The average towboat speed is judged to have exceeded 73.5 kph/45.7 mph, as checked by a GPS speed-measuring device.
- (5) **Contact with Ramp.** In the opinion of the Boat Judge, the skier advantageously contacts the ramp with anything other than the feet. The Chief Judge can be called upon to adjudicate if the Boat Judge is unable to make an immediate ruling.

- (C) **BSP after Jump.** After landing a jump, the skier can throw the handle after attaining BSP.

- (D) **End of Course.** Once the Boat Judge has recognized BSP, he may request the Driver to start slowing the towboat.

1409: SCORING

His longest registered jump distance in a round shall be declared the skier's score for that round.

1410: JUMP MEASUREMENT AND CALCULATION

- (A) **Jump Computer Program.** A WBC approved video jump-measurement program shall be used to obtain jump distances. Such a system will not be subject to reading errors, shall produce results that are reproducible on readily available systems, and the distance gleaned from the video will be final.
- (B) **Measuring Jump Distance.** There shall be two Event Judges stationed at the video monitor who shall agree on the positioning of the cursor. If necessary, they shall use the video replay facility to determine the landing point. If the two Event Judges fail to agree, a third Appointed Judge shall be called in and he will position the cursor himself. The median value among the three distance read-outs shall be taken as the official jump distance.

1412: DISTANCE

- (A) **Points of Measurement.** Jump distances shall be measured from a point on the surface of the water perpendicularly below the center of the top edge of the ramp, to the point of contact closest to the ramp.
- (B) **Measurement Increments.** Jump distances shall be scored in increments of 10cm.
- (C) **Skier Not Making Landing Box.** In the case of a successful jump that is unreadable due to the skier not making it to the landing box, the distance awarded will be the lowest distance readable on the screen, minus one-tenth meter.
- (D) **Skier Exceeding Landing Box.** In the case of a successful jump that is unreadable due to the skier jumping past the landing box, the distance that will be awarded will be the longest readable distance **on the screen**, plus one-tenth meter.

CHAPTER 15: SLALOM EVENT

1501: EQUIPMENT

The towboat shall contain a tournament-supplied rope and handles meeting the requirements of 1103.

1502: PASSES

- (A) **Two 15-Second Passes.** In each round each skier shall be allowed two 15-second passes through the Slalom course, one forward and one backward, during which the skier can score points.
- (B) **Two Forward Passes.** If both passes are in the forward BSP or any portion of a pass is made in the forward BSP, then the points for the lower-scoring forward pass or portion of the forward pass shall be calculated at 25 percent of the scored value rounded to two decimal places (.01).
- (C) **Combination Backward/Forward Pass.** If during a backward pass a skier, for whatever reason changes to the forward position, the skier can recommence crossing forward and receive credit for those forward crossings as set out in 1502(B).

1503: STARTING

The skier shall attain BSP by any start trick listed in 1603 and may reverse direction before starting the Slalom pass.

1504: BOAT SPEED AND PATH

- (A) **Course Speed.** Once the skier's requested course speed is achieved, it shall be held constant to within ± 1 kph or $\pm \frac{1}{2}$ mph until the shutdown buoy is reached.

Note: The failure of the towboat to achieve the requested course speed 'above' 72 kpm/44.7 mph through the course is not grounds for a re-ride [906(E)].

- (B) **Speed Signal for Skier.** When requested by the skier, a signal from the Boat Judge shall be given when the requested speed is attained as follows:
- (1) **Signal.** This signal can take the form of sound, a hand signal or a tap/chop on the rope.

- (2) **Signal Not Required.** The requested signal is not required if the skier starts the pass before the requested speed.

- (C) **Path.** During the pass the towboat shall follow a straight path, approximately down the center of the course until the shut-down buoy is reached or the 15 seconds expires, whichever is first.

1505: START OF PASS

- (A) **Audible Timing Device.** The Boat Judge(s) shall start the audible timing device at the beginning of the Slalom pass. The audible timing device shall sound at the beginning and at the end of the pass.
- (B) **Start of Slalom Pass.** Time and scoring of the Slalom pass shall commence with the skier's first movement toward the wake from BSP outside the wake.

Note: The wake is defined as the area of water disturbed by the passage of the towboat lying at ropes length between and including the crest of the wake waves [102].

- (1) The skier can either attain BSP outside the wake on his preferred side, or in the wake and go out straight to either side.
- (2) Making a positioning turn preparatory to starting the pass or testing the speed with a one-foot is not considered the skier's first movement toward the wake.
- (3) If the skier skis away from the wake before starting to cross (i.e. to attack the wake or gain momentum), this will not be held to be a first movement toward the wake, and the pass will not start until the skier turns back toward the wake.
- (4) Drifting into the curl of the wake following the start is not to be considered a first movement toward the wake.

1506: END OF PASS

- (A) **Audible Timing Device.** The expiry of the 15-second time interval from the beginning of the pass, marked by the sounding of an audible timing device or the stopping of the towboat shall signify the end of the pass.
- (B) **Shut-down Buoy.** If the towboat passes the shut-down buoy before the 15 seconds have elapsed, the Driver shall smoothly close the throttle and maintain a safe path till the towboat stops. The skier is free to continue crossings while the towboat is slowing down and the Boat Judges will continue to record them, noting when the timing device sounds at the end of the 15 seconds.

1507: OFFICIALS

- (A) **Recording.** Boat Judge(s) shall watch and record independently each crossing made by the skier as it's performed and note the exact position of the skier at the start and end of the pass.
- (B) **Continue Scoring.** Boat Judge(s) shall continue to crossing made after the expiry of the 15 seconds, regardless of speed or path of the towboat.
- (C) **Written Record.**
- (1) The Boat Judge(s) shall make a written record, in accordance with the slalom shorthand, of the identity and success of each crossing as it's performed.

Note: See 1510(B) for one-foot crossing downgrade symbols.

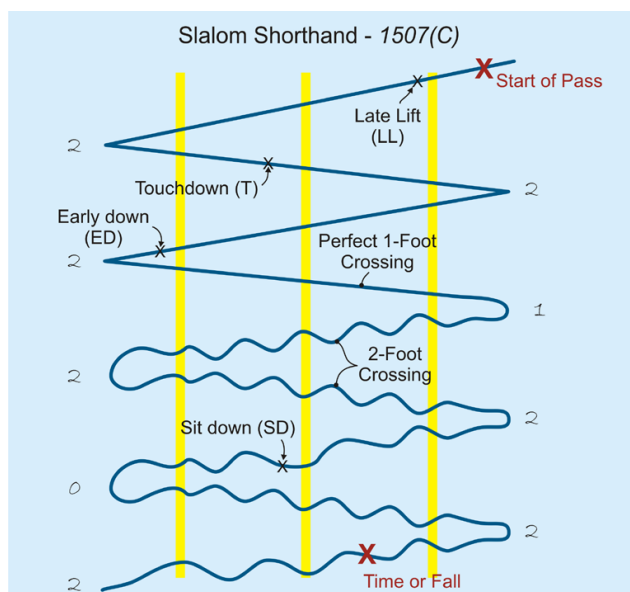

- (2) Supplements to this record for which there was insufficient opportunity during the pass or the correction of writing errors or misconceptions can be made after the pass ends, but only before the sheet is discussed for scoring in the boat or handed over to the Scorers except as permitted in video review [706].
- (a) Additions or corrections shall not be made to the score sheet once the sheet has been discussed or handed over to the Scorers.
- (b) Except to provide provisional results as permitted in 604, there shall not be any communication of the score sheets with the other Boat Judges until after the event's protest period has expired.

- (D) **Judging.** The Boat Judge(s) shall independently decide and record with respect to each crossing the following:

- (1) Where the crossing started and ended.
- (2) Whether the crossing was a two-foot, imperfect one-foot, or perfect one-foot crossing.
- (3) If the crossing was an imperfect one-foot crossing i.e. the skier lifted up late, touched down between the waves of the wake, or put down early, this shall be clearly marked on the score sheet at the place where it occurs.
- (4) Whether the crossing was a partial one-foot or partial two-foot crossing.
- (5) The reason for the ending if a partial crossing.
- (6) If the crossing was performed according to the rules.

- (E) **Boat Scoring.** After completing their sheets, the Boat Judges shall communicate with each other to arrive at a simple majority and to convey that decision to the Scorer.

1509: CREDIT FOR SLALOM

- (A) **Skier Responsibility.** It is responsibility of the skier to show the Boat Judge(s) that he has fully crossed the wake in BSP on one foot or two feet.

Note: The wake is the area of water disturbed by the passage of the towboat lying at rope's length between and including the crest of the wake waves [102].

(B) Two-Foot Crossing.

- (1) **Full.** A perfect two-foot crossing is credited when the skier has crossed the wake in BSP on two feet.
- (2) **Partial.** The skier will receive credit for a partial two-foot crossing when the:
 - (a) Crossing in progress is interrupted by the expiry of time.
 - (b) Skier loses the handle during the crossing.

(C) One-Foot Crossing.

- (1) **Full.** A perfect one-foot crossing is credited when the skier has crossed the wake in BSP with the lifted foot/leg completely clear of the water before the lift-off point of the first wake wave and remains completely clear of the water until the skiing foot has passed the lift-off point of the second wake wave. The skier shall hold the lifted foot/leg high enough over the wake so that it can be seen from the towboat without doubt to be clear of the wake.

Note: The skier is judged not on what he knows he did, but what he "shows he did" to the Boat Judges

- (2) **Partial.** A partial one-foot crossing shall only be credited if its part of a perfect one-foot crossing during which the 15-second period expires.

(D) Points Scored. Points shall be awarded for full and partial crossings made during the pass as follows:

(1) Full Two-Foot Crossings.

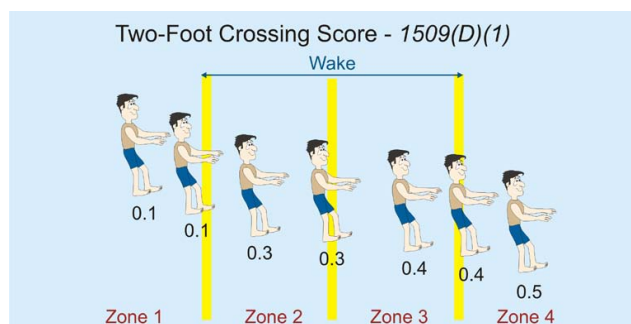

(a) A full two-foot crossing in accordance with 1509(B)(1) shall be scored as 0.5 points (Zone 4).

(b) A partial two-foot crossing judged in accordance with 1509(B)(2) shall be scored as follows:

- (1) 0.1 points if the skier is in movement toward the wake, but not yet having both feet inside the first wave of the wake (Zone 1).
- (2) 0.3 points if the skier has both feet inside the first wave of the wake (Zone 2).
- (3) 0.4 points if the skier has both feet past the centerline of the wake (Zone 3).

(2) One-Foot Crossings.

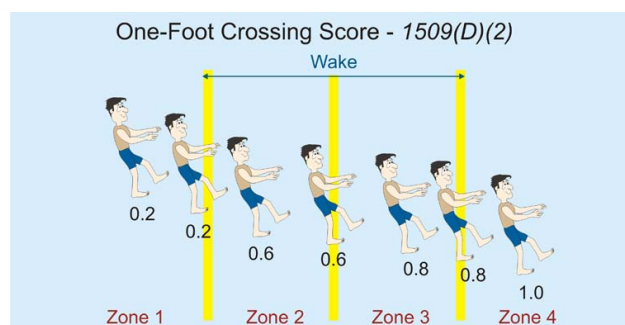

(a) A perfect one-foot crossing, in accordance with 1509(C)(1), shall be scored as 1.0 points (Zone 4).

(b) A partial one-foot crossing, in accordance with 1509(C)(2), shall be scored as follows:

- (1) 0.2 points if the skier is in movement toward the wake, but not yet having past the lift-off point of the first wake wave with the supporting foot (Zone 1).
- (2) 0.6 points if the skier has passed the lift-off point of the first wake wave but has not passed the center with the supporting foot (Zone 2).

(3) 0.8 points if the skier has passed the center of the wake but has not passed the lift-off point of the second wake wave with the supporting foot (Zone 3).

(c) An imperfect one-foot crossing shall be scored as a two-foot crossing in accordance with 1509(D)(1).

(E) Scoring Zero. The crossing in which the skier is engaged shall score zero if:

(1) **Loses BSP.** The skier loses BSP during the crossing but retains the handle, e.g. sit or fall/tumble up, or

(2) **Crossing Back.** The skier turns back during the crossing without having crossed over the entire wake in BSP. The skier can continue crossings and scoring recommences only from BSP outside the wake.

(2) **Touch (T).** A touch shall be recorded when the skier's lifted foot touches the water surface between the lift-off points while the supporting foot is between the lift-off points of the wake waves.

(3) **Early Down (ED).** An early down shall be recorded when the skier's lifted foot touches the water surface beyond the second lift-off point while the supporting foot has yet to clear the second lift-off point of the wake waves.

Note: See Table 1507(C) for slalom shorthand symbols.

(C) No Majority. In the case of no simple majority on any fault zone of a one-foot crossing, the crossing shall score as a one-foot crossing.

(D) Expiration of Time. The end of scoring zone shall be determined by a simple majority of two or more Boat Judges agreeing on the same zone.

(1) In the case of three Boat Judges recording three different zones for the end of scoring zone, the end of scoring zone shall be determined from video review.

(2) Where video is not available for review, the end of scoring zone shall be determined by the highest zone that has an agreement between two Boat Judges.

Note: If Judge 1 has Zone 1, Judge 2 has Zone 2 and Judge 3 has Zone 3, Judge 2 and Judge 3 have both agreed the skier has at least achieved Zone 2 so the highest agreed scoring end of scoring zone is Zone 2.

1510: SCORING

(A) Simple Majority. The Scorers shall receive the score sheet(s) and decide the crossings to be scored, based on a simple majority from among the Boat Judges' individual score sheets. Points shall be awarded for full and partial crossings made during the pass as set out in 1509.

(B) One-Foot Crossing Downgrade. Downgrading an imperfect one-foot crossing to a two-foot crossing requires a simple majority of two or more Boat Judges agreeing on the same fault zone for that crossing. The three fault zones shall be as follows:

(1) **Late Lift (LL).** A late lift shall be recorded when the skier's lifted foot touches the water surface between the lift-off points before the supporting foot reaches the first lift-off point of the wake wave.

CHAPTER 16: TRICKS EVENT

1601: EQUIPMENT

(A) Tournament-Supplied Equipment. The towboat shall contain a tournament-supplied rope and handle as set out in 1103.

Note: The skier is permitted to furnish his own rope(s) and handle(s) of any size, length and material, including a lightweight clip [1103(E)].

(B) Equipment for Second Pass. It is the skier's responsibility to ensure that any equipment required by the skier for the second pass be placed in the towboat prior to the first pass.

Note: Should an emergency develop during or after the first pass with skier's equipment, the skier is permitted to return to the starting dock in the towboat only to obtain replacement equipment in accordance with the Emergency Minute rules contained in 108(C).

1602: PASSES

In each round, each skier shall be allowed two 15-second passes through the tricks course during which the skier can score start and pass trick points.

1603: STARTING

(A) Start Methods. The skier shall attain BSP by means of any of the following starts:

(1) **Front Deep-to-Two.** On the "OK" command, the skier shall be pulled up-to-speed according to his instructions with his body facing upwards. He shall then place both feet onto the water and in one attempt raise himself to forward BSP and hold for recognition. The skier is permitted to touch the rope with his foot or feet during the start.

(2) **Front Deep-to-One.** On the "OK" command, the skier shall be pulled up-to-speed according to his instructions with his body facing upwards. He shall then place one foot onto the water and in one attempt raise himself to forward one-foot BSP and hold for recognition. During the entirety of the start the skier shall only touch the rope or the water surface with the foot he will stand up on.

The foot to be lifted must not touch the water surface or the rope for the rest of the start. If the lifted foot touches either the rope or water before one-foot BSP is recognized, the start shall be downgraded to a front deep-to-two if it meets the requirements of 1603(A) (1).

(3) **Back Deep-to-Two.** On the "OK" command, the skier shall be pulled up-to-speed according to his instructions with the handle held behind his back, his body facing downwards, and his feet toward the towboat. He shall then place both his feet onto the water and in one attempt raise himself to backward BSP and hold for recognition. The skier is permitted to touch the rope with his foot or feet during the start.

(4) **Back Deep-to-One.** On the "OK" command, the skier shall be pulled up-to-speed according to his instructions with the handle held behind his back, his body facing downwards, and his feet toward the towboat. He shall then place his foot onto the water and in one attempt raise himself to backward one-foot BSP and hold for recognition. During the entirety of the start the skier shall only touch the rope or the water surface with the foot he will stand up on.

The foot to be lifted must not touch the water surface or the rope for the rest of the start. If the lifted foot touches either the rope or water before one-foot BSP is recognized, the start shall be downgraded to a back deep-to-two if it meets the requirements of 1603(A) (3).

- (5) **Front Tumble-to-Two.** On the “OK” command, the skier shall be pulled headfirst with his legs trailing behind him up-to-speed according to his instructions. The skier may come out of deep water on either his stomach or back. While on his back, the skier shall then swing his legs round from the trailing position to the forward position and in one attempt raise himself to forward two-foot BSP and hold for recognition.
- (6) **Front Tumble-to-One.** On the “OK” command, the skier shall be pulled headfirst with his legs trailing behind him up-to-speed according to his instructions. The skier may come out of deep water on either his stomach or back. While on his back, the skier must then swing his legs round from the trailing position to the forward position. He shall then place one foot onto the water and in one attempt raise himself to forward one-foot BSP and hold for recognition.

From the point where he brings his legs round from the trailing position, only the foot he will stand up on shall touch the rope or the water surface. If the lifted **leg gains support of the rope or the lifted** foot touches either the rope or water before one-foot BSP is recognized, the start shall be downgraded to a front tumble-to-two if it meets the requirements of 1603(A)(5).

During the rotation to the forward position the skier may hesitate or pause but shall not reverse direction. Any reversal of direction during the rotation will incur a 50 percent penalty. Overshoot is permitted.

- (7) **Back Tumble-to-Two.** On the “OK” command, the skier shall be pulled headfirst with his legs trailing behind him while holding the handle behind his back up-to-speed according to his instructions. The skier may come out of deep water on his stomach, side, or back. While on his stomach the skier must, without reversing direction of rotation, then swing his legs round from the trailing position to the forward position and in one attempt raise himself to backward two-foot BSP and hold for recognition. During the rotation the skier may hesitate or pause but shall not reverse direction. Any reversal of direction during the rotation will incur a 50 percent penalty. Overshoot is permitted.

- (8) **Back Tumble-to-One.** On the “OK” command, the skier shall be pulled headfirst, on his back or front, with his legs trailing behind him while holding the handle behind his back up-to-speed according to his instructions. The skier may come out of deep water on his stomach, side, or back. While on his stomach the skier must, without reversing direction of rotation, then swing his legs round from the trailing position to the forward position. He shall then place one foot onto the water and in one attempt raise himself to backward one-foot BSP and hold for recognition.

From the point where he brings his legs round from the trailing position, only the foot he will stand up on shall touch the rope or the water surface. If the lifted **leg gains support of the rope or the lifted** foot touches either the rope or water before one-foot BSP is recognized, the start shall be downgraded to a back tumble-to-two if it meets the requirements of 1603(A)(7).

During the rotation to the backward position the skier may hesitate or pause but shall not reverse direction. Any reversal of direction during the rotation will incur a 50 percent penalty. Overshoot is permitted.

(9) **Front Toe-Up.** On the “OK” command, the skier shall be pulled up-to-speed according to his instructions. His body shall be facing upwards, pulled entirely by the foot in the toe-strap of his handle. Both feet are permitted to touch the toe-strap. The hands are permitted to touch the water surface or spray during the start.. He shall then place his free foot onto the water and in one attempt raise himself into forward rope-on-foot BSP and hold for recognition. The hands shall not touch the handle during the entirety of the start. The skier may steady himself by holding the leg while the towboat accelerates or rising into BSP.

(10) **Back Toe-Up—Perfect Version.** On the “OK” command, the skier shall be pulled up-to-speed according to his instructions. His body shall be facing downwards (on his stomach) for the entire start and shall be pulled entirely by the foot in the toe-strap of his handle. Both feet are permitted to touch the toe-strap. From a position on his stomach, he shall place his free foot onto the water and in one attempt raise himself in to backward rope-on-foot BSP and hold for recognition. The hands may touch the water surface during the raise portion of the start but shall be held clear for recognition once backward rope-on-foot BSP has been achieved.

(11) **Back Toe-Up—Imperfect Version.** On the “OK” command, the skier shall be pulled up-to-speed according to his instructions. His body shall be facing upwards (on his back/butt). For the entirety of the start the skier shall be pulled entirely by the foot in the toe-strap of his handle. Both feet are permitted to touch the toe-strap.

Once the skier is planing, he shall roll over onto his stomach, and remain in a face downward position for the remainder of the start trick. From a position on his stomach he shall place his free foot onto the water and in one attempt raise himself in to backward rope-on-foot BSP and hold for recognition. The hands may touch the water surface during the raise-portion of the start but shall be held clear for recognition once backward rope-on-foot BSP has been achieved.

(B) Start Points.

Start Points - 1603(B)				
	Two Feet	One Foot	Flyer Bonus	Tower Bonus
Front Deep	50	100	50	150
Front Toe-Up		400		
Front Tumble	100	150	50	100
Back Deep	200	500	100	200
Back Toe-Up		450/350*		
Back Tumble	400	700	100	200
	*Imperfect Version [1603(A)(11)]			

(C) Tower. Provision of a tower is optional at LOC discretion, and where provided it shall be between 2.5m and 5m above the water surface.

(D) Flying or Tower Flying Start. To receive credit for a flying or tower start:

- (1) **Towboat Movement.** The towboat moves slowly off without stopping while the skier readies himself, and accelerates away on the ‘OK’ command from the skier. The skier’s instructions shall ensure that the towboat is accelerating when he hits the water after leaping off the dock, dry land, or tower.
- (2) **Skier Action.** After the skier has taken at least one hop, skip or step, the skier shall propel himself up and out from the dock, dry land, or tower and there shall be an instant when the whole of the skier is clearly above the point of takeoff.
- (3) **Back Flyer.** The skier must be facing in the direction of travel of the towboat and is not permitted to trail the handle and line between the legs. On signaling his readiness to go by the “OK” Command, the skier must complete the handle pass while he is in the air, while at the same time turning to the backward position prior to landing on to the water.

(E) Scoring. To receive credit for two starts in a round, the skier shall successfully perform two different starts listed in Table 1603(A).

- (1) **Successful Start.** The points for a successful start trick will be credited whether or not the subsequent trick pass is credited.

- (2) **Failed Start.** A failed start does not affect the scoring of a subsequent successful trick pass.
- (3) **Repeated Two-Foot Start.** Where a two-foot start has been successfully repeated, only the higher-paying start will be credited.
- (4) **Repeated One-Foot Start.** Where a one-foot start has been successfully repeated:
 - (a) The higher-paying start will be credited.
 - (b) The repeated start shall be downgraded to a two-foot start and credited.
- (F) **Second Pass Start.** The start for the second pass shall commence from deepwater.
- (G) **Skier Persists.** The skier is permitted to persist with the start until the towboat passes the shut-down buoy **and comes to rest.**

1604: TOWBOAT SPEED AND PATH

- (A) **Start Speed.** Once the skier's requested start speed is achieved, it shall be held constant to within ± 1 kph or $\frac{1}{2}$ mph until the start is complete. Immediately following the start portion of the pass, the speed shall be adjusted to the requested course speed.

Note: The failure of the towboat to achieve the requested course speed 'above' 72 kpm/44.7 mph through the course is not grounds for a re-ride [906(E)].

- (B) **Course Speed.** Once the skier's requested course speed is achieved, it shall be held constant to within ± 1 kph or $\frac{1}{2}$ mph until the shutdown buoy is reached.

Note: The failure of the towboat to achieve the requested course speed greater than 72 kpm/44.7 mph before the skier advisory buoy or through the course is not grounds for a re-ride [906(E)].

- (C) **Speed Signal for Skier.** A signal from the Boat Judge shall be given on request when the requested start or course speed is attained.
 - (1) **Signal Form.** This signal can take the form of sound, a hand signal or a tap/chop on the rope.

- (2) **Signal Not Required.** The requested signal is not required only if the skier starts the pass before the requested speed.

- (E) **Path.** During the pass the towboat shall follow a straight path, approximately down the center of the course until the shut-down buoy is reached or the 15 seconds expires, whichever is first.

1605: START OF PASS

- (A) **Audible Timing Device.** The Boat Judge(s) shall start the audible timing device at the beginning of the trick pass. The audible timing device shall sound at the beginning and at the end of the 15-second pass.

- (B) **Beginning of Trick Pass.** Time and scoring shall begin at the skier's first movement toward doing a pass trick after gaining BSP.

- (1) **Preparatory Tricks.** The skier is permitted to perform preparatory tricks necessary to get into position for his first trick. This shall not be considered a first movement.

- (a) Preparatory tricks shall be declared to the Boat Judges in the skier's instructions.
- (b) If the skier fails to declare preparatory tricks, the Boat Judges will start the timer at the skier's first movement toward a trick.
- (c) If the skier fails to perform his declared preparatory tricks, the pass will start as soon as the skier makes a movement toward any other trick.

Note: See 105(C)(6) for requirements of skier instructions relating to preparatory tricks.

1606: END OF PASS

- (A) **Audible Timing Device.** The end of the 15-second pass shall be marked by the sounding of an audible timing device.

(B) Shut-down Buoy. If the towboat passes the shut-down buoy before the 15 seconds have elapsed, the Driver shall smoothly close the throttle and maintain a safe path till the towboat stops. The skier is free to continue executing tricks while the towboat is slowing down and the Boat Judges will continue to record them, noting when the timing device sounds the end of the 15 seconds.

(b) Except to determine the last trick in time or to provide provisional results as permitted in 604, there shall not be any communication of the score sheets with the other Boat Judges until after the event's protest period has expired.

1607: OFFICIALS

(A) Recording. The Boat Judge(s) shall watch and independently record each trick attempted by the skier. The Boat Judge(s) shall continue to record tricks made after the expiry of the 15 seconds and decide with respect to each trick:

- (1) If it was performed in accordance with the rules.
- (2) If the trick was completed before the end of the pass.
- (3) If any penalties apply to the trick.

(B) Continue Scoring. The Boat Judge(s) shall continue to record tricks made after the expiry of the 15 seconds, regardless of speed or path of the towboat.

(C) Written Record. The Boat Judge(s) shall make a written record, in accordance with the Trick Shorthand Table of the identity and success of each trick as it's performed. This record shall note the direction of a turn, and on which foot if a one-foot trick.

- (1) Supplements to this record for which there was insufficient opportunity during the pass or the correction of writing errors or misconceptions can be made after the pass ends, but only before the sheet is discussed for scoring in the towboat or handed over to the Scorers, except as permitted in video review [706].
 - (a) Additions or corrections shall not be made to the score sheet once the sheet has been discussed or handed over to the Scorers.

Short-Hand Tricks Symbols -1607(C)									
	Surface Tricks				Wake Tricks				Wake-to-Wake
	Two Foot		One Foot		Two Foot		One Foot		
	Basic	Rev	Basic	Rev	Basic	Rev	Basic	Rev	
General									
Hop	Λ		Λ>	<Λ	Λv				Λw
Knee Skiing	K								
One Foot			>	<					
Rope in Teeth	T		T>	<T					
Rope on Neck	N		N>	<N					
Side Slide-Backward	BSS								
Side Slide-Forward	SS								
Side Slide Switch	SSS								
Sit Down Stand Up	SD		SD>	<SD					
Somersault (Flip)	O				Ov				Ow
Toe Hold			C.	.C					
Tumble 180	↵	↶	↵>	<↶					
Tumble 360	↷	↸	↷>	<↸					
Wave-One Hand	W.	.W							
Turns									
180° Turn	1.	.1	1>	<1	1v	v1	1>v	v<1	1w
360° Turn	3.	.3	3>	<3	3v	v3	3>v	v<3	3w
540° Turn	5.	.5	5>	<5					
720° Turn	7.	.7	7>	<7					
Step Turn 180°	S1	1S			Sv	vS			Sw
Step Turn 360°	S3	3S							
Step Turn 540°	S5	5S							
Step Turn 720°	S7	7S							
Toe Turn			C1	1C			Cv	vC	

(D) Last Trick in Time. Between passes, the skier is permitted to ask the Boat Judges the last trick in time; the Boat Judges shall confer to reach a simple majority on the last trick completed in time and communicate that simple majority to the skier.

(E) Boat Scoring. After completing their sheets, the Boat Judges shall communicate with each other to arrive at a simple majority and to convey that decision to the Scorer.

1608: CREDIT FOR PASS TRICKS

Pass tricks are credited in two phases, according to technical and logical criteria.

- (1) **Technical Criteria.** The technical criteria are the descriptions contained in 1613 through 1622 and are applied by the Boat Judges. Tricks are assessed in isolation without regard to what happens before or after.

- (2) **Logical Criteria.** After technical approval, tricks are examined in the light of logical criteria, which involve the relationships to other tricks and the setting of the trick in the two-pass round.

(A) General

- (1) **Trick Choice.** Only pass tricks listed in this Chapter can be scored in a tournament.
- (2) **Skier Responsibility.** It is the responsibility of the skier to:
- (a) Make each action and movement clear to the Boat Judge(s), taking into account the distance, water spray, speed of movement and other factors affecting the ability of a Boat Judge to discern the prescribed actions when performing a trick.
 - (b) Clearly pause between tricks to allow the trick to be recognized and to ensure that the following trick is being started from BSP.

(B) Highest Scoring Sequence. The highest scoring sequence of turns that complies with all rotation rules shall be used for scoring a trick run.

(C) Loss of BSP.

- (1) If a skier falls prior to the trick being held for recognition, the trick will not be credited.
- (2) If prior to the trick being held for recognition, the skier loses BSP and allows himself to fall to a position that requires a greater than 90-degree tumbleturn to recover and is able to regain BSP, the trick and tumbleturn recovery will not be credited, but the skier can continue his trick pass.
- (3) If the skier loses BSP between tricks due to neither trick but is able to regain BSP, the skier shall incur no penalty and can continue his trick pass.

(D) Tricks at Expiration of Time.

- (1) Tricks not completed before the end of the pass shall not be credited.

- (2) Tricks that occur after expiry of time shall not be considered and shall bear no influence in deliberations of the validity of the last trick completed in time.

(E) Reverse Tricks

- (1) A reverse trick shall immediately follow the basic trick.
- (2) A basic and reverse performed in different passes shall not both score.
- (3) The reverse shall not be disallowed simply because it follows an attempted basic trick which has not been credited or because the basic trick is a repeated trick.
- (4) A reverse which follows an unsuccessful basic can be considered the basic for an immediate repeat of the original basic, which then becomes the reverse for the purpose of this rule.
- (5) A failed reverse trick can immediately be reattempted. The skier is permitted to persist in this attempt until the trick has been credited or time expires. The credited basic trick need not be repeated. The turn rotation rule 1613(B) will be suspended for the purposes of this rule so as to allow a failed reverse turn to be reattempted.
- (6) A basic and reverse trick correctly performed, shall be eligible for scoring even if one or both are repeat(s) of trick(s) previously performed in the same or the other pass. Such previously scored trick(s) shall then be annulled unless this conflicts with 1608(C).

(F) One-Foot Tricks.

- (1) In the case of a one-foot, it's immaterial which foot is lifted.
- (2) The reverse of a one-foot, rope-in-teeth one-foot, rope-on-neck one-foot, rope-on-foot, sit down-stand up one-foot, or tumbleturn one-foot tricks shall be on the opposite foot.

- (G) Feet to Feet.** With the exception of sit down-stand ups, tumbleturns and somersaults, perfect (full credit) pass tricks shall be performed feet to feet, i.e. starting and finishing on the foot or feet with no other part of the body contacting the water in between. Should any other part of the body make contact with water before the trick has been held for recognition, the trick shall be judged as an imperfect trick and shall incur a penalty as per 1610.
- (H) Simultaneous Tricks.** In the event that two tricks are performed simultaneously, only the higher scoring of the two tricks shall score unless that trick has previously been scored, in which case the lower-scoring trick shall score.

1609: BONUS ACTIONS

- (A) Bonus Values.** The following pass tricks carry a bonus value (basic and reverse), which are treated as separate from the whole trick and judged and scored as bonuses:

- (1) Hop-Front (one foot) – 50 points *
- (2) Hop-Back (one foot) – 100 points *
- (3) Hop-Back (line step) – 100 points *
- (4) One Foot (line step) – 100 points

** Bonus is permitted for both feet, thus allowing two one-foot hops with bonus credit.*

- (B) Double Credit.** With the exception of tumbleturns, a skier cannot be credited with a trick and then credited again with the repeated trick and the bonus. Where a skier performs a trick and repeats the trick with a bonus, the skier will only be credited with the bonus points for the repeated trick.
- (C) Tumbleturns.** For tumbleturns, the one-foot stand-up is a bonus action and does not constitute the entirety of the trick; therefore the one-foot success or failure cannot determine failure of a tumbleturn.

1610: PENALTIES AND REVERSIONS

- (A) BSP in One Attempt.** Following any imperfect trick the skier shall attain BSP in one attempt.
- (B) Tumbleturns.**

- (1) When attempting a 180-degree tumbleturn, the skier will incur a penalty of 50 percent of the value of the trick if his feet pass 90 degrees but do not reach the full 180 degrees.
- (2) When attempting a tumbleturn, an overshoot of more than 90 degrees will disallow the trick. This applies to the 180-degree portion when the legs are trailing during a 180-degree tumbleturn and when the skier has returned to the forward position in both 180 and 360-degree tumbleturns.
- (3) During the rotation to the forward position of a tumbleturn **for start and pass tricks**, the skier may hesitate or pause but may not reverse direction. Any reversal of the rotation direction during the turn to the forward position will incur a penalty of 50 percent of the value of the trick.

- (C) Rope-on-Foot.** When attempting a rope-on-foot, if the skier has placed his foot inside the toe-strap while in BSP but was unsuccessful in attaining rope-on-foot BSP before the end of the pass, the skier will incur a 75-point penalty for a forward rope-on-foot or a 100-point penalty for a backward rope-on-foot.

- (1) The Boat Judges shall see the skier truly attempting the rope-on-foot trick.
- (2) Only one imperfect rope-on-foot shall be credited in any one 15-second pass.
- (3) The handle used must be appropriate for the trick being attempted.

Note: A failed rope-on-foot is not a separate trick and is classed as an imperfect rope-on-foot.

- (D) Surface/Wake Turns.** The skier will incur a 100-point penalty if he loses BSP before recognition of the trick but successfully completes the trick and regains BSP. A fall to a position that requires a greater than 90-degree tumbleturn to recover will disallow the trick.

- (1) **If the skier commences a turn before one-foot BSP has been recognized, it shall be judged as a two-foot turn and all rotation rules contained in 1613(B) shall apply.**

- (2) If the skier fails to satisfy the lifted-foot requirements during the rotation of a one-foot turn or before BSP has been recognized at the end of the trick but relifts the lifted foot to one-foot BSP before moving on to the next trick then the trick will be judged as an imperfect one-foot turn and it shall incur a 100-point penalty. Should the skier fail to relift to one-foot BSP, the turn shall not score.
- (3) A hand touch at the end of, or during, any turn will incur a 100-point penalty.

(E) Wake Tricks.

- (1) Wake tricks may revert to a surface trick if the wake criteria have not been met, provided the trick satisfies all criteria for the surface trick.
- (2) Wake-to-wake tricks may revert to a single wake trick provided the wake criteria have been met for either wake.

(F) Rope-on-Foot Turn.

- (1) When attempting a front-to-back rope-on-foot turn, the skier will incur a 100-point penalty if he does not maintain BSP throughout the turn or if the hands are not clear from the handle prior to the turn.
- (2) When attempting a back-to-front rope-on-foot turn, the skier will incur a 550-point penalty if, after having maintained rope-on-foot BSP throughout the turn, the skier takes the handle before the trick has been held for recognition.
- (3) When attempting a back-to-front rope-on-foot turn, the skier will incur a 550-point penalty if he does not maintain BSP throughout the turn.

(G) Step-Over-Turn.

- (1) When attempting any step-over-turn, the skier will incur a 100-point penalty if any other part of the body touches the water surface before the trick has been held for recognition.

(H) Somersault.

- (1) When attempting a somersault, if the feet go over the level of the head but do not go through the vertical plane of the head, the skier will incur a 250-point penalty. It shall be noted that although the plane of rotation shall be vertical, it would be inclined to the tow-boat path in a wake or wake-to-wake somersault as the skier cuts across.
- (2) Somersaults with any degree of tumbleturn recovery up to a maximum of 90 degrees shall be judged an imperfect recovery and will incur a 250-point penalty. A recovery of more than 90 degrees shall disallow the trick.

1611: PRECURSORY TRICKS**(A) One-Foot.**

- (1) When executing a one-foot trick, once the skier makes any move toward a hop, rope-on-foot, or one-foot turn, then a one-foot trick shall **not** be permitted to be **credited** regardless whatever happens to the subsequent trick.
- (2) Holding one-foot BSP for recognition after completing a one-foot trick shall never be paid as a one-foot, whether or not the one-foot trick succeeded.

(B) Rope-on-Foot.

- (1) When executing a rope-on-foot, once the skier makes any move toward a toe-turn, then a rope-on-foot trick shall **not** be **credited**, regardless whatever happens to the subsequent trick.
- (2) Holding rope-on-foot BSP for recognition after completing a rope-on-foot turn trick shall never be paid as a rope-on-foot, whether or not the turn trick succeeded.
- (3) **To receive credit for a rope-on-foot trick prior to a rope-on-foot turn, the foot must be removed completely from the toe-strap and then replaced to commence the second trick.**

- (C) **Side Slide.** When executing a side slide, once the skier makes any move toward a switch-stance side slide the basic side slide will not be credited.

1612: GENERAL PASS TRICKS

(A) One Hand Wave. While maintaining stable BSP, the skier shall release his hand up and **raise it above the level of the shoulder.**

(B) Sit Down-Stand Up.

(1) The skier must, from BSP, sit down on the water surface, clearly showing his feet to be clear of the water surface and then raise himself to forward BSP again and hold for recognition.

(2) Sit Down-Stand Up One Foot. The skier must, from BSP, sit down on the water surface, clearly showing his feet to be clear of the water surface. He shall then place one foot onto the water and in one attempt raise himself to forward one-foot BSP and hold for recognition. From the point where he brings his feet off of the water, only the foot he will stand up on is permitted to touch the rope or the water surface. Basic and reverse shall be allowed in addition to the two-foot version.

(C) One-Foot (Forward or Backward). The skier shall demonstrate forward or backward BSP supported entirely by one foot. The free foot shall be raised to a position at least halfway between the skier's other knee and the water surface and held for recognition.

Note: The bonus for a one-foot basic and reverse in the step-over position is 100 points each [1609(A)].

(D) Knee Ski. The skier must, from BSP, go down onto his knees **and** hold for recognition.

(E) Rope-on-Neck.

(1) **General.**

- (a) The hands shall be released from the handle and be clearly visible simultaneously.
- (b) To receive credit for a two-foot rope-on-neck trick in a series, it shall always precede the one-foot tricks.
- (c) No re-gripping of the handle is permitted in between performing the neck two-foot, one-foot, and reverse tricks.

(d) Should the skier re-grip the handle during a series of neck tricks, the skier shall remove the handle from the neck and re-initiate the series to receive credit for the full series of tricks.

(2) **Two-Feet.** While using a rope-on-foot trick handle the skier shall place the handle over the head and behind the neck and then the skier shall release the hands completely from any part of the handle or rope while maintaining BSP and hold for recognition.

(3) **One-Foot.** While maintaining rope-on-neck BSP, the skier shall raise one foot to a position at least halfway between the skier's knee and the water surface. The foot shall be lifted before or after the hands are released, but the foot shall be held long and high enough so that the lifted foot and released hands can be clearly seen simultaneously.

(4) **Delete.** Rope-on-Neck tricks shall be deleted as credited tricks the day following the close of 2012 World Championships.

(F) Rope-in-Teeth.

(1) **General**

- (a) The hands shall be released from the handle and be clearly visible simultaneously.
- (b) To receive credit for a two-foot rope-in-teeth trick in a series, it shall always precede the one-foot tricks.
- (c) No re-gripping of the handle is permitted in between performing the teeth two-foot, one-foot and reverse tricks.
- (d) Should the skier re-grip the handle during a series of teeth tricks, the skier shall remove the handle from the teeth and re-initiate the series to receive credit for the full series of tricks.

(2) **Two-Feet.** The skier shall place the teeth piece in his mouth. The skier shall then release the hands from any part of the handle while maintaining BSP and hold for recognition.

- (3) **One-Foot.** While maintaining rope-in-teeth BSP, the skier shall raise one foot to a position at least halfway between the skier's knee and the water surface. The foot shall be lifted before or after the hands are released, but the foot shall be held long and high enough so that the lifted foot and released hands can be clearly seen simultaneously.
- (4) **Delete.** Rope-in-Teeth tricks shall be deleted as credited tricks the day following the close of 2012 World Championships.

(G) Tumbleturns.

- (1) **General.**
- To obtain the one-foot bonus, from the moment the skier is on his back, the lifted foot shall touch neither the water nor the rope for the rest of the trick.
 - At the conclusion of a tumbleturn, BSP shall be attained and held for recognition.
 - The reverse of a tumbleturn two-foot shall be rotated in the opposite direction.
 - The reverse of a tumbleturn one-foot shall be both rotated in the opposite direction and to the opposite foot.
- (2) **180 -Degree Tumbleturn.**
- Two-Feet.** While in forward BSP, the skier shall lower himself to the water and execute a 180-degree revolution on his back arriving in a headfirst position. The 180-degree position is considered achieved when the feet of the skier are judged to have reached or passed the line of the rope. The skier will then stop, and reverse the direction of the turn, return to the forward facing position, regain forward BSP in one attempt, and hold for recognition.

- One-Foot.** The skier shall perform a 180-degree tumbleturn and regain BSP on one foot and hold for recognition. The lifted foot shall be held visibly clear of the surface of the water and the rope from the moment the skier goes down onto his back until one-foot BSP is regained and has been recognized.

(3) 360- Degree Tumbleturn.

- Two-Feet.** While in forward BSP, the skier shall lower himself to the water and execute a 360-degree revolution on his back around to the forward facing position, regain BSP in one attempt, and hold for recognition.
- One-Foot.** The skier shall perform a 360-degree tumbleturn and regain BSP on one foot, and hold for recognition. The lifted foot shall be held visibly clear of the surface of the water and the rope from the moment the skier goes down onto his back and until one-foot BSP is regained and has been recognized.

- (H) **Hop.** (Forward or Backward). The skier shall jump from the surface of the water into the air and land again in BSP. During the jump the skier shall be completely clear of the water surface.

Note 1: The bonus for a forward one-foot hop is 50 points and for a backward one-foot hop is 100 points [1609(A)].

Note 2: The bonus for a backward hop in the step-over position is 100 points [1609(A)].

- Wake Hop (Forward or Backward).** While in BSP outside the wake, the skier shall jump over the wake wave and land on the other side of the same wake wave in BSP. A forward single-wake jump can be performed from either inward or outward, and no reverse is permitted.
- Wake-to-Wake Hop (Forward or Backward).** While in BSP outside the wake, the skier shall jump the entire wake and shall be completely clear of the water, landing outside the second wake crest in BSP. The skier may jump from either side of the wake, and no reverse trick is permitted.

(I) Rope-on-Foot (Forward or Backward). While in BSP, the skier shall lift one foot and place it in the toe-strap. With his weight supported by the foot on the water, the skier shall then release his hands completely from any part of the handle so that the handle is held by the foot only. The hands shall be seen to be clear of the handle and the water surface long enough for recognition. Subsequent recovery of the handle is not a requirement.

(J) Side Slide.

- (1) **Forward.** While in forward BSP, the skier shall rotate both feet to a position 90° to the line of the towboat path in one continuous movement and hold for recognition.
- (2) **Backward.** While in backward BSP, the skier shall rotate both feet to a position 90° to the line of the towboat path in one continuous movement and hold for recognition.
- (3) **Switch Stance.** While in BSP, the skier shall rotate both feet to a position 90° to the line of the towboat path in one continuous movement, and hold for recognition. With his weight supported by both feet and without changing the direction the skier is facing, the skier shall then slide both feet to the opposite position and then back to the original side slide position and hold for recognition.

(K) Wake Tricks.

- (1) Any rotation of a wake trick shall be completed in midair during a jump off the wake wave. The skier shall land on the other side of the crest in BSP.
- (2) The skier shall remain completely clear of the water surface during the entire trick or turn.
- (3) In making a wake trick, the skier may use the whole of the upslope and ski through the crest of the wave to propel himself into the air.
- (4) Wake rope-on-foot turns shall take off and land on the foot. Water contact with any body part before the foot will disallow the trick.

(L) Wake-To-Wake Tricks.

- (1) A wake-to-wake trick is a trick performed in the air during a jump off the wake wave.

- (2) The skier may use the whole of the upslope and ski through the crest of the wave to propel himself into the air.
- (3) The skier shall jump high enough to bridge the entire wake and shall be completely clear of the water till clearing the second wake crest, landing outside the second wake crest on his feet. The skier is permitted to sit or fall back if he is unable to hold BSP, provided he subsequently regains BSP in one attempt and holds it for recognition.
- (4) A forward wake-to-wake jump is permitted to be performed either the left or right side of the wake, but only one trick shall be scored.

1613: TURN TRICKS GENERAL

(A) General. Turns shall be judged in two ways:

- (1) **Perfect Turn.** If the skier remains in BSP (or in the air for a wake trick) throughout the turn and thereafter holds BSP for recognition, he shall be credited with full points.
- (2) **Imperfect Turn.** If the skier loses BSP and contacts the water before recognition of the trick but successfully completes it and regains BSP, the trick will be paid with a penalty of 100 points. Failure to recover within the pass disallows the trick.
- (3) The reverse of a turn trick shall be in the opposite direction of rotation.
- (4) Any variety of 180-degree or 540-degree turn is allowed between 180-degree or 540-degree basic and reverse turns.
- (5) In tick-tock turns, it's not necessary for the handle to be taken in both hands, and the completeness of rotation shall be judged on the position of the feet alone. He shall however demonstrate the ability to hold the forward and backward positions at will.
- (6) In a multiple turn any interruption in the continuous turning movement shall terminate the trick at that point and it shall score zero. A variation in the speed of rotation shall not constitute an interruption of the turn.

- (7) No more than eight one-foot and eight two-foot multiple turns shall be scored in any round.
- (8) No more than four step-over multiple turns shall be scored in any round.

(B) Rotation of Consecutive Surface Turn Tricks.

This rotation rule applies only to uninterrupted sequences of like turns. This requirement does not apply:

- (1) When a one-foot surface turn follows a two-foot surface turn or vice versa, or when the skier sets his foot down and raises it again for a further one-foot turn.
- (2) To wake turns, or wake-to-wake turn tricks.
- (3) At the conclusion of a one-foot turn trick, a skier is permitted to commence another one-foot turn trick in the opposite direction without first returning to the two-foot BSP. However, the skier shall pause for BSP recognition.
- (4) When a two-foot or a one-foot surface turn trick immediately follows another of the same kind, the rotation shall be in the opposite direction, except for the reverse 540 and 180 turns, which can be in the same rotation as the positional turn.
- (5) If the skier makes consecutive two-foot or one-foot turns in the same direction with no other trick in between, they shall be treated as a failed multiple turn and neither shall be credited.
- (6) When attempting a one-foot turn, the skier must show one-foot BSP prior to commencing any turning motion.

1614: 180 BACK-TO-FRONT

(A) 180 Back to Front.

- (1) **Two-Feet.** While in backward BSP the skier shall execute a 180-degree turn to forward BSP and hold for recognition.
- (2) **One-Foot.** While in backward one-foot BSP the skier shall execute a 180-degree turn to forward one-foot BSP and hold for recognition. The skier shall maintain one-foot BSP throughout the entirety of the trick.

(B) Wake 180 Back to Front.

- (1) **Two-Feet.** While in backward BSP, the skier shall jump over the wake wave and execute a 180-degree turn in midair, landing on the far side of the wake wave in forward BSP and hold for recognition. The skier shall be seen to be completely clear of the water surface and the wake throughout the entirety of the turn.
- (2) **One-Foot.** While in backward one-foot BSP, the skier shall jump over the wake wave and execute a 180-degree turn in mid air, landing on the far side of the wake wave in forward one-foot BSP and hold for recognition. The skier shall maintain one-foot BSP throughout the entirety of the trick. The skier shall be seen to be completely clear of the water surface throughout the entirety of the turn.

- (C) Wake-to-Wake 180 Back-to-Front.** While in backward BSP, outside the wake the skier shall jump over the entire wake and execute a 180-degree turn in midair, landing on the far side of the second wake wave in forward BSP and hold for recognition. The skier shall be seen to be completely clear of the water surface and wake throughout the entirety of the turn.

1615: 180 FRONT-TO-BACK

(A) Surface 180 Front-to-Back.

- (1) **Two-Feet.** While in forward BSP, the skier shall execute a 180-degree turn to backward BSP and hold for recognition.
- (2) **One-Foot.** While in forward one-foot BSP the skier shall execute a 180-degree turn to backward one-foot BSP and hold for recognition. The skier shall maintain one-foot BSP throughout the entirety of the trick.

(B) Wake 180 Front-to-Back.

- (1) **Two-Feet.** While in forward BSP, the skier shall jump over the wake wave and execute a 180-degree turn in midair, landing on the far side of that wake wave in backward BSP and hold for recognition. The skier shall be seen to be completely clear of the water surface throughout the entirety of the turn.

- (2) **One-Foot.** While in forward one-foot BSP, the skier shall jump over the wake wave and execute a 180-degree turn in midair, landing on the far side of the wake wave in backward one-foot BSP and hold for recognition. The skier shall maintain one-foot BSP throughout the entirety of the trick. The skier shall be seen to be completely clear of the water surface throughout the entirety of the turn.

- (C) **Wake-to-Wake 180 Front-to-Back.** While in forward BSP outside the wake, the skier shall jump over the entire wake and execute a 180-degree turn in mid-air, landing on the outside of the second wake wave in backward BSP and hold for recognition. The skier shall be seen to be completely clear of the water surface and wake throughout the entirety of the turn.

1616: 360 FRONT-TO-FRONT

(A) Surface 360 Turns.

- (1) **Two-Feet.** While in forward BSP, the skier shall execute a continuous 360-degree turn. At the conclusion of the turn, the skier shall be in forward BSP and hold for recognition.
- (2) **One-Foot.** While in forward one-foot BSP, the skier shall execute a continuous 360-degree turn returning to forward one-foot BSP and hold for recognition. The skier shall maintain one-foot BSP throughout the entirety of the trick.

- (B) **Wake 360 Front-to-Front.** While in forward BSP, the skier shall jump over the wake and execute a continuous 360-degree turn in midair, landing on the far side of that wake in forward BSP and hold for recognition. The skier shall be seen to be completely clear of the water surface throughout the turn.

- (C) **Wake-to-Wake 360 Front-to-Front.** While in forward BSP outside the wake, the skier shall jump over the wake wave and execute a continuous 360-degree turn in midair, landing on the far side of the second wake wave in forward BSP and hold for recognition. The skier shall be seen to be completely clear of the water surface and wake throughout the entirety of the turn.

1617: 360 BACK-TO-BACK

(A) Surface 360 Back-to-Back.

- (1) **Two-Feet.** While in backward BSP, the skier shall execute a continuous 360-degree turn and return to backward BSP and hold for recognition.
- (2) **One-Foot.** While in backward one-foot BSP, the skier shall execute a continuous 360-degree turn returning to backward one-foot BSP and hold for recognition. The skier shall maintain one-foot BSP throughout the entirety of the trick.

- (B) **Wake 360 Back-to-Back.** While in backward BSP, the skier shall jump over the wake and execute a continuous 360-degree turn in midair, landing on the far side of the same wake in backward BSP and hold for recognition. The skier shall be seen to be completely clear of the water surface throughout the turn.

- (C) **Wake-to-Wake 360 Back-to-Back.** While in backward BSP outside the wake, the skier shall jump over the wake wave and execute a continuous 360-degree turn in midair, landing on the far side of the second wake wave in backward BSP and hold for recognition. The skier shall be seen to be completely clear of the water surface and wake throughout the entirety of the turn.

1618: 540 TURNS

(A) 540 Back-to-Front.

- (1) **Two-Feet.** While in backward BSP, the skier shall execute a continuous 540-degree turn to forward BSP and hold for recognition.
- (2) **One-Foot.** While in backward one-foot BSP, the skier shall execute a continuous 540-degree turn to forward one-foot BSP and hold for recognition. The skier shall maintain one-foot BSP throughout the entirety of the trick.

(B) 540 Front-to-Back.

- (1) **Two-Feet.** While in forward BSP, the skier shall execute a continuous 540-degree turn to backward BSP and hold for recognition.

- (2) **One-Foot.** While in forward one-foot BSP, the skier shall execute a continuous 540-degree turn to backward one-foot BSP and hold for recognition. The skier shall maintain one-foot BSP throughout the entirety of the trick.

1619: 720 TURNS

(A) 720 Front-to-Front.

- (1) **Two-Feet.** While in forward BSP, the skier shall execute a continuous 720-degree turn and return to forward BSP and hold for recognition.
- (2) **One-Foot.** While in forward one-foot BSP, the skier shall execute a continuous 720-degree turn returning to forward one-foot BSP and hold for recognition. The skier shall maintain one-foot BSP throughout the entirety of the trick.

(B) 720 Back-to-Back.

- (1) **Two-Feet.** While in backward BSP, the skier shall execute a continuous 720-degree turn and return to backward BSP and hold for recognition.
- (2) **One-Foot.** While in backward one-foot BSP, the skier shall execute a continuous 720-degree turn, returning to backward one-foot BSP and hold for recognition. The skier shall maintain one-foot BSP throughout the entirety of the trick.

1620: STEP-OVER LINE TURN

(A) General.

- (1) In making a step-over turn, one leg is passed over the rope during the turn. Accidental contact with the rope during the step over will not disallow the trick.
- (2) Contact with the spray will not disallow the trick.
- (3) The step-over and turn actions shall be simultaneous.
- (4) Whether or not the foot that passes over the rope is subsequently set down shall not disallow the trick.

- (5) In a step-over wake turn the leg shall pass over the rope while the skier is in the air.
- (6) In a multiple step-over turn both legs shall pass over the rope in succession, changing feet at mid-point, and the turning movement shall be without hesitation.

(B) Step-Over Tricks

- (1) **180 Step-Back-to-Front.** While holding the handle between his legs in backward BSP, the skier shall simultaneously execute a 180-degree turn while stepping over the rope to forward BSP and hold for recognition.
- (2) **Wake 180 Step-Back-to-Front.** While holding the handle between his legs in backward BSP, the skier shall simultaneously jump over the wake wave, step over the rope, and turn 180-degrees while in the air, landing on the far side of that wake wave in forward BSP and hold for recognition. The skier shall be seen to be completely clear of the water surface and wake throughout the entirety of the turn.
- (3) **180 Step-Front-to-Back.** While in forward BSP, the skier shall simultaneously execute a 180-degree turn while stepping over the rope to backward BSP and hold for recognition.
- (4) **Wake 180 Step-Front-to-Back.** While in forward BSP, the skier shall simultaneously jump over the wake wave, step over the rope, and turn 180-degrees while in the air, landing on the far side of that wake wave in backward BSP and hold for recognition. The skier shall be seen to be completely clear of the water surface and wake throughout the entirety of the turn.
- (5) **360 Step-Back-to-Back.** While in backward BSP, the skier shall execute a continuous 360-degree turn, simultaneously stepping over the rope as he goes from back to front and again as he comes from front to back, returning to backward BSP and hold for recognition.

- (6) **360 Step-Front-to-Front.** While in forward BSP, the skier shall execute a continuous 360-degree turn, simultaneously stepping over the rope as he goes from front to back and again as he comes from back to front, returning to forward BSP and hold for recognition.
- (7) **540 Step-Back-to-Front.** While in backward BSP, the skier shall execute a continuous 540-degree turn, simultaneously stepping over the rope as he goes from back to front, front to back, and back to front, returning to forward BSP and hold for recognition.
- (8) **540 Step-Front-to-Back.** While in forward BSP, the skier shall execute a continuous 540-degree turn, simultaneously stepping over the rope as he goes from front to back, back to front, and front to back, returning to backward BSP and hold for recognition.
- (9) **720 Step-Back-to-Back.** While in backward BSP, the skier shall execute a continuous 720-degree turn, simultaneously stepping over the rope as he goes from back to front, front to back, back to front, and front to back, returning to backward BSP and hold for recognition.
- (10) **720 Step-Front-to-Front.** While in forward BSP, the skier shall execute a continuous 720-degree turn, simultaneously stepping over the rope as he goes from front to back, back to front, front to back, and back to front, returning to forward BSP and hold for recognition.

1621: ROPE-ON-FOOT TURN

- (A) **180 Rope-On-Foot Back-to-Front.** While in backward rope-on-foot BSP, the skier shall execute a 180-degree turn to forward rope-on-foot BSP and hold for recognition.
- (B) **180 Rope-On-Foot Front-to-Back.** While in forward rope-on-foot BSP, the skier shall execute a 180-degree turn to backward rope-on-foot BSP and hold for recognition.
- (C) **Prior to Commencing.** The skier must show rope-on-foot BSP prior to commencing any turning motion.

1622: SOMERSAULT

(A) General.

- (1) To incur full credit the plane of rotation shall be vertical, like a fan blade, so that during the somersault the heels do actually pass directly over the head. It shall be noted that although the plane of rotation shall be vertical, it's permitted to be inclined to the towboat path. Failure to regain BSP in one attempt will disallow the entire trick.
- (2) In a wake somersault, after take-off, no part of the body shall touch the water on the take off side of the wake until the trick has been held for recognition.
- (3) In a wake-to-wake somersault, after take-off, no part of the body shall touch the water inside the wake until the trick has been held for recognition.
- (4) Wake somersaults shall be performed from inside to outside of the wake except in the case of 1610(E).
- (5) A maximum of three somersaults can be scored in any round.
- (6) Reverse surface somersaults are NOT allowed.
- (7) A reverse wake-to-wake somersault shall immediately follow the basic and can only be performed in the opposite direction to the basic trick.
- (8) Reverse wake somersaults shall immediately follow the basic and can only be performed from the inside to the outside of the opposite wake of the basic trick and shall immediately follow the basic.

(B) Somersault Tricks.

- (1) **Somersault.** While in forward BSP, the skier shall perform a somersault (heels over head) in the air, landing on the skier's feet, butt, back or head, whereupon he shall regain BSP in one attempt.

- (2) **Wake Somersault.** While in forward BSP, inside the wake the skier shall perform a somersault while jumping over the wake wave and landing on the other side of the same wake wave.
- (3) **Wake-to-Wake Somersault.** While in forward BSP, outside the wake the skier shall jump over the entire wake and perform a somersault, landing on the outside of the second wake wave.

1623: SCORING – TRICK POINT VALUES

The Scorers shall receive the score sheets and points shall be awarded for tricks made during the pass in accordance with the Trick Point Values Table. In the event of a discrepancy, the Scorers shall decide the tricks to be scored on the basis of a simple majority from among the Boat Judges individual score sheets as to:

- (1) What tricks were performed,
- (2) If they were performed according to the rules governing that trick,
- (3) If any penalties apply, and
- (4) What was the last trick completed before the end of a pass.

	Trick Point Values - 1623				
	Surface Tricks		Wake Tricks		Wake-to Wake
	Two Foot	One Foot	Two Foot	One Foot	
General					
Hop-Back	100*		150§		250§
Hop-Front	20*		30§		100§
Knee Skiing	30				
One Foot-Back		100*			
One Foot-Forward		30			
Rope in Teeth	20	50	Rope in Teeth/Neck Eliminated in 2013		
Rope on Neck	20	50			
Side Slide - Backward	300§				
Side Slide - Forward	150§				
Side Slide - Switch	400§				
Sit Down Stand Up	20	40			
Somersault (Flip)	500/250§				
Toe Hold-Backward		150/50	650		900
Toe Hold-Forward		100/25			
Tumble 180	50/25	100/50	*Bonus Trick - 1609(A) Front Hop 1-foot 50 Back Hop 1-foot 100 Line Back Hop 100 Line Back 1-foot 100 § One only i.e. no reverse		
Tumble 360	50/25	100/50			
Wave-One Hand	10				
Turns - Surface					
180 Back to Front	200/100	350/250	300/200	500/400	500
180 Front to Back	250/150	350/250	400/300	500/400	600
360 Back to Back	550/450	1050/950	700/600	1200/1100	900
360 Front to Front	450/350	950/850	600/500	1100/1000	800
540 Back to Front	750/650	1350/1250			
540 Front to Back	850/750	1450/1350			
720 Back to Back	1050/950	1850/1750			
720 Front to Front	950/850	1750/1650			
Turns - Step					
Step 180 Back to Front	350/250		500/400		850
Step 180 Front to Back	450/350		600/500		
Step 360 Back to Back	950/850				
Step 360 Front to Front	850/750				
Step 540 Back to Front	1250/1150				
Step 540 Front to Back	1350/1250				
Step 720 Back to Back	1850/1750				
Step 720 Front to Front	1750/1650				
Turns - Toe					
Toe 180 Back to Front		850/300		1500/550	
Toe 180 Front to Back		350/250		700/600	

1624: NEW TRICKS

To qualify new tricks for inclusion in the next World Championships, applications for those new tricks shall be submitted to any member of the WBC no less than 120 days before the next World Championships and the WBC shall then adjudicate them on no less than 60 days before the next World Championships. This application shall be in the form of a video recording of the perfect trick on the long line accompanied by a written description of the trick.

CHAPTER 17: WORLD RECORDS

1701: RECOGNITION

The WBC shall recognize World Records for Jump Distance, Slalom crossings, and Tricks points for all divisions. The Confederations are permitted to recognize records for divisions other than those recognized by the IWWF. The nationality of the skier rather than the location of the tournament shall determine the Confederation in which a record is recognized.

1702: TOURNAMENT

- (A) **Where Set.** Records shall be set only at tournaments homologated by the WBC, a Confederation, or an Affiliated Federation.
- (B) **Boat Judge Qualification.** At least one Boat Judge shall be Level 2 and no more than one shall be Level 4.
- (C) **Number of Rounds.** No more than three rounds are eligible for setting records in any one competition, except that four rounds are eligible in a head-to-head competition.
- (D) **Declaring Record Eligible Rounds.** The record eligible rounds shall be declared before the start of the competition.

1703: JUMP

If the longest official distance credited in the jump event of a tournament exceeds the official record by 10cm or more, it shall be considered for a new record. If this distance equals the existing record distance, the skier will become co-holder of the established record.

1704: SLALOM AND TRICKS

If the best performance in the Slalom or Tricks events of a tournament exceeds the official record, it will be considered for a new record. If this performance equals the existing record, the skier will become co-holder of the existing record.

1705: EQUAL PERFORMANCE

If at a tournament a World record score is equaled, the World record shall be co-held, no matter who may be the ultimate winner of the event.

1706: AFFIDAVIT—CLAIM DOCUMENTATION

- (A) **Homologator.** Specifications of equipment, courses, and measuring devices shall be as specified in the WBC Technical Rulebook and the Official World Record Forms, which shall be completed and certified by the Homologator and all other required officials.
- (B) **Review in Descending Order.** All performances in all record eligible rounds equal to or exceeding the existing record shall be put forward, and reviewed in descending order until the best that can be verified is established.
- (C) **Qualified Review.** The most qualified officials available shall review the claim and all details as per 1706(D) and 1705(E) while at the tournament. Whenever possible, the Confederational Record Review Committee member should be included in the review of the claim before submission to the RRC Chairman. If this reviewing panel is satisfied that it's valid and the paperwork is in order, the claim shall be put forward as per 1706(F).
- (D) **Slalom and Trick Records.** For Slalom and Tricks records, the original Boat Judges scoring sheets and a DVD of the recording of the passes constituting the record taken from the towboat shall accompany the record application.
- (E) **Jump Record.** A jump record application shall include the set-up file and two images—One image of the landing box and one of the jump landing—on magnetic media. To ensure that the skier does not obscure the landing box buoys that are necessary for record review, an image of the landing box with no skier using the same camera set-up as the record claim image is necessary.

- (F) **Submission Deadline.** The Homologator shall send a completed record application form, all magnetic media and/or DVD, score sheets, and a copy of the homologation dossier to each member of the WBC Record Review Committee within **fourteen days** of the completion of an event.

Note: Refer to www.WorldBarefootCouncil.com for application and contact details.

- (G) **Confirm Receipt of Application.** The Chairperson of the WBC Records Review Committee (RRC) is to confirm receipt of the record application via E-mail to the submitting Federation within one week of receipt.

1707: VERIFICATION

- (A) **RRC Membership.** The RRC shall consist of one representative from each Confederation. The RRC shall adjudicate all World Records.
- (B) **Decision Within 30 Days.** Within 30 days of the receipt of records, documents, and media, the RRC shall assess and promulgate the outcome of the record application.
- (C) **Federation Notified.** The Chairperson of the RRC is to advise the Federation and applicant on the outcome of the record application via E-mail.
- (D) **Slow Motion and Frame/Frame Review.** The RRC is free to use slow motion or frame-by-frame to review a record application.

1708: RECORD APPEALS

- (A) **Review by Entire WBC.** If a member of the RRC is aggrieved by a decision made by that Committee, they have the right to appeal the decision to the WBC. A review process by the entire WBC is then initiated.
- (B) **Review at Next Regular Meeting.** The WBC will itself scrutinize any appealed record application no later than its next meeting.
- (C) **Slalom and Trick.**
- (1) **Item by Item.** The DVD for a record shall be viewed trick-by-trick or crossing-by-crossing and shall be judged item by item. Each item shall be approved by at least a two-thirds majority of the WBC.

- (2) **Scored as a Whole.** When all items of a Slalom crossing or Trick are approved, it shall be considered approved as a whole.

- (D) **Jump.** The cursor position for a jump landing shall be approved by at least a two-thirds majority of the WBC.

1709: RATIFICATION

All WBC Members shall be notified via E-mail of the new record and of the date of ratification as per 1707(B).

1710: RECORDS SET AT WORLD CHAMPIONSHIP

- (A) **Immediate Notification.** The World Scoring Program shall be programmed to highlight any score that exceeds an existing World Record. The Scorers shall immediately forward this information to the Chief Judge, the Homologator, and the Chief Video Officer.
- (B) **Before the End of Championship.** Whenever possible, the RRC shall adjudicate all World Records set at World Championships before the end of the Championships.
- (C) **Substitute RRC Member.** The RRC shall scrutinize, approve or reject all World Records set at the Championships. If any member of the permanent RRC is not in attendance at the Championships or is unable to fulfill the commitment for any other reason, the WBC Chairman shall appoint a substitute committee member from among the Level 1 Judges in attendance. This substitute should be a WBC Member whenever possible.
- (D) **Appeal.** If any RRC member is aggrieved by a decision made by the RRC, the WBC shall scrutinize and approve or deny the pending record at the World Championships.
- (E) **Homologator Responsibilities.** The Homologator shall consult with the RRC Chairman and the Chief Judge immediately upon notification of a pending record to facilitate the preparation of all documentation to enable the immediate review of any pending World Records. The Homologator tasks include:
- (1) Sourcing the original Judge's sheets.

- (2) Sourcing a copy of the video recording/DVD of the pending record.
 - (3) Coordinate a panel of Judges and immediately review the pending record.
 - (4) Prepare the required paperwork for presentation to the RRC Chairman after the review panel approves the pending record.
- (F) Documents to Skier or Team Representative.** The Chief Judge of the World Championships shall provide the Skier or Team Representative all evidence and documentation necessary for substantiating any pending National or Confederational record set at the World Championships.
- (G) Others Afforded Access for Record Verification.** The Team Representative and any of his Confederational Council or WBC Members shall also be afforded the facilities to scrutinize the pending record or make record verification.

INDEX

COURSE REQUIREMENTS

Emergency Minute.....	5
Jump Course.....	2
Skier Instructions.....	3
Slalom and Trick Course.....	2
Turn-Around Times.....	5

DIVISIONS AND EVENTS

Completion.....	10
Disqualification.....	11
Divisions of Competition.....	8
Driver Familiarization.....	9
Event Rounds.....	8
Events.....	8
Finals.....	10
Interruptions and Stoppage.....	10
Schedule of Events.....	8
Semifinals.....	9
Site Familiarization.....	8
Starting Order.....	9
The Draw.....	9

EVENT, OVERALL AND TEAM RANKING

Champions.....	15
Event Placing.....	15
Overall Placing.....	16
Overall Scoring—Application.....	16
Overall Scoring—Calculation.....	16
Qualification for Overalls.....	16
Results Posting.....	17
Score Sheets.....	17
Team Placing.....	16
Ties.....	15

GENERAL REQUIREMENTS

Amendments to the Rules.....	6
Application.....	6
Exceptions to the Rules.....	6
interpretation of the Rules.....	6
Rule Change Procedure.....	6
Rules Revision.....	6
Scheduling.....	6
Site Closure and Set Up.....	7
Validity.....	7
Voting.....	7

Boat Speed and Path.....	32
Credit for Jump.....	33
Distance.....	34
Jump Measurement and Calculation.....	34
Jump Ramp.....	32
Officials.....	33
Passes—Jumps.....	33
Scoring.....	33
Start of Pass—Jump Attempt.....	3
Starting.....	32

OFFICIALS

Affidavit.....	19
Appointed Judges, Scorers and Drivers.....	18
Chief Officials.....	18
Independence.....	19
Minimum Requirements for Boat Officials.....	19
Replacing Officials.....	19
Secondary Positions.....	18

PROTESTS

Basis.....	26
Calculation Error.....	26
Chief Judge Decision.....	26
Fee.....	26
Procedure.....	26

RE-RIDES

Not Basis for a Re-Ride.....	24
Provisional Scores.....	25
Refusal to Enter Course.....	25
Re-Ride Request.....	24
Re-Rides in the Jump Event.....	23
Re-Rides in the Slalom Event.....	23
Re-Rides in the Trick Event.....	23
Same Instructions.....	25
When a Re-Ride Is Granted/Required.....	23

SAFETY

Flotation and Protection.....	21
Helmets.....	21
On-Site Medical Facilities.....	22
Safety Director.....	21
Safety Personnel.....	21
Temporary incapacitation.....	21

SLALOM EVENT

Boat Speed and Path.....	35
Credit for Slalom.....	36
End of Pass.....	36
Equipment.....	35
Officials.....	36
Passes.....	35
Scoring.....	38
Start of Pass.....	35
Starting.....	35

SPEED CHECKS

Method.....	30
Top Speed Advisory.....	30

TOWBOATS, ROPES, HANDLES, AND TIMERS

Boat Specifications.....	27
Ropes and Handles.....	28
Timers.....	29
World Championships.....	28

TRICKS EVENT

180 Back-to-Front.....	50
180 Front-to-Back.....	50
360 Back-to-Back.....	51
360 Front-to-Front.....	51
540 Turns.....	51
720 Turns.....	52
Bonus Actions.....	45
Credit for Pass Tricks.....	43
End of Pass.....	42
Equipment.....	39
General Pass Tricks.....	47
New Tricks.....	54
Officials.....	43
Passes.....	39
Penalties and Reversions.....	45
Precursory Tricks.....	46

Rope-On-Foot Turn.....	53
Scoring—Trick Point Values.....	54
Somersault.....	53
Start of Pass.....	42
Starting.....	39
Step-Over Line Turn.....	52
Towboat Speed and Path.....	42
Turn Tricks General.....	49

VIDEO

Appointments.....	20
Assignment.....	20
Availability.....	20
Boat Loading.....	20
Media.....	20
Official Use.....	20

WORLD CHAMPIONSHIP ENTRY REQUIREMENTS

Certification.....	13
Entry Registration.....	13
Independent Entrants.....	13
Jump Proficiency.....	13
Nationality.....	12
Team Composition.....	12

WORLD RECORDS

Affidavit—Claim Documentation.....	55
Equal Performance.....	55
Jump.....	55
Ratification.....	56
Recognition.....	55
Record Appeals.....	56
Records Set At World Championship.....	56
Slalom and Tricks.....	55
Tournament.....	55
Verification.....	56

GRAPHICS AND TABLES

Wake Smooth Shoulder - 102

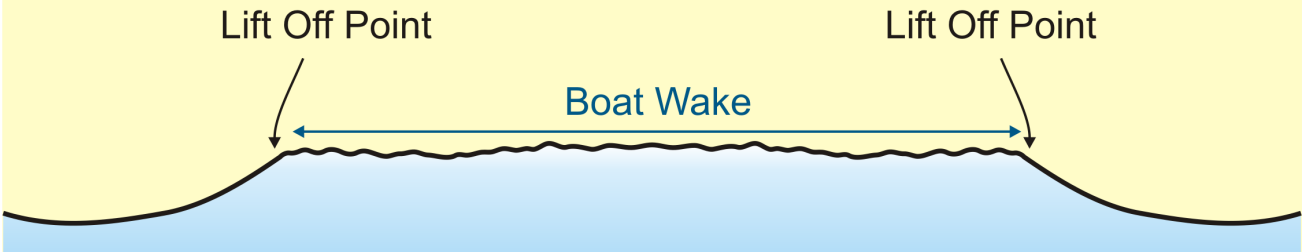

Wake Curled Shoulder - 102

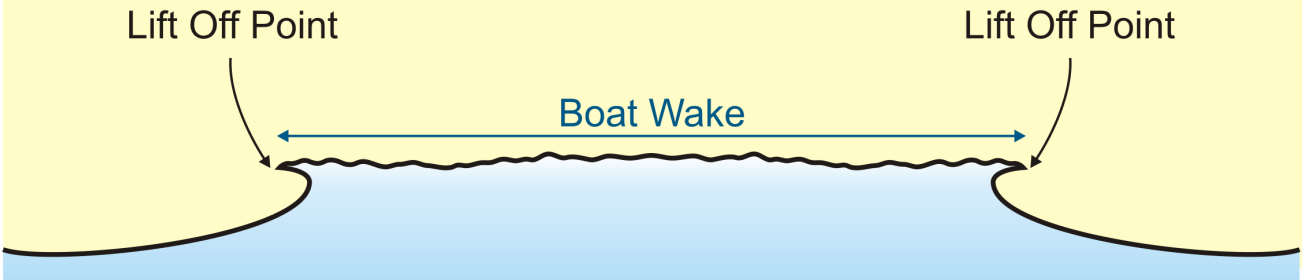

Jump Course Dimensions - 103(A)

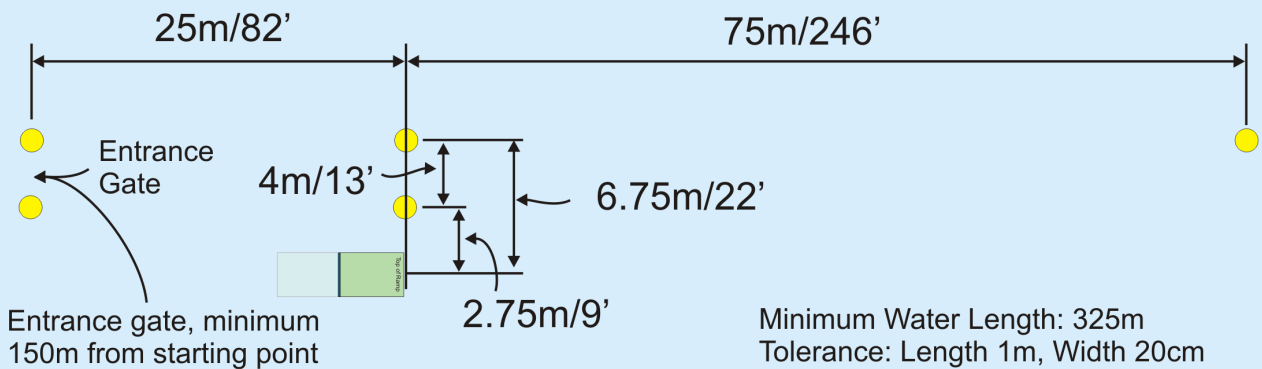

Slalom/Trick Course - 104(A)

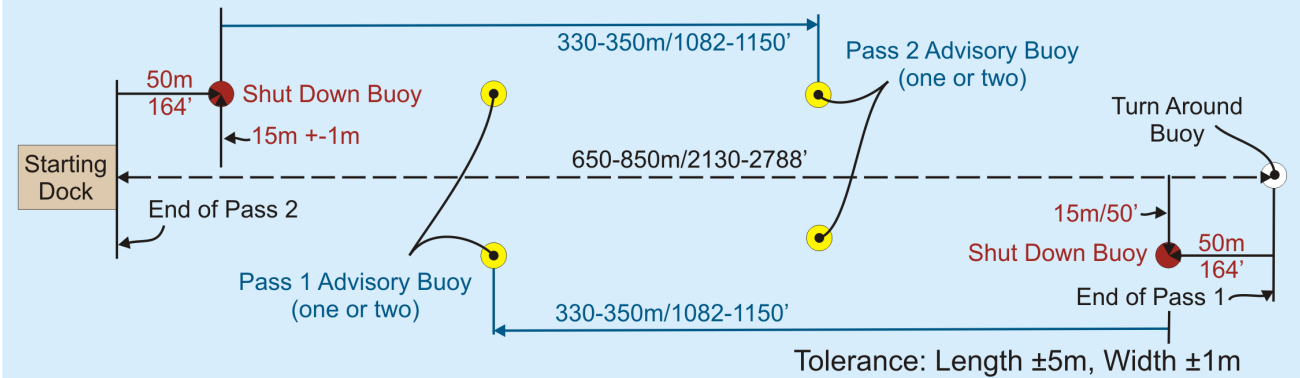

Jump Handle - 1103(D)

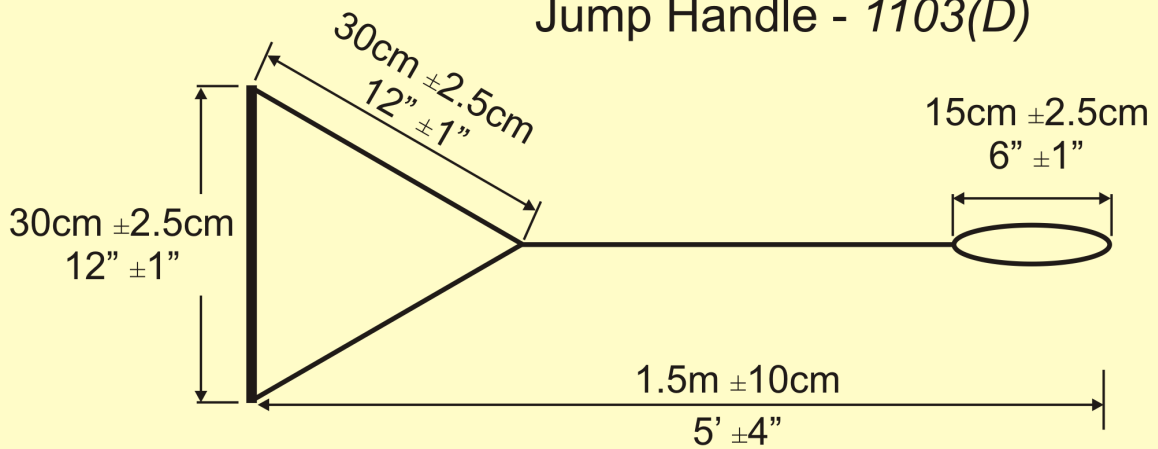

Slalom Handle - 1103(E)

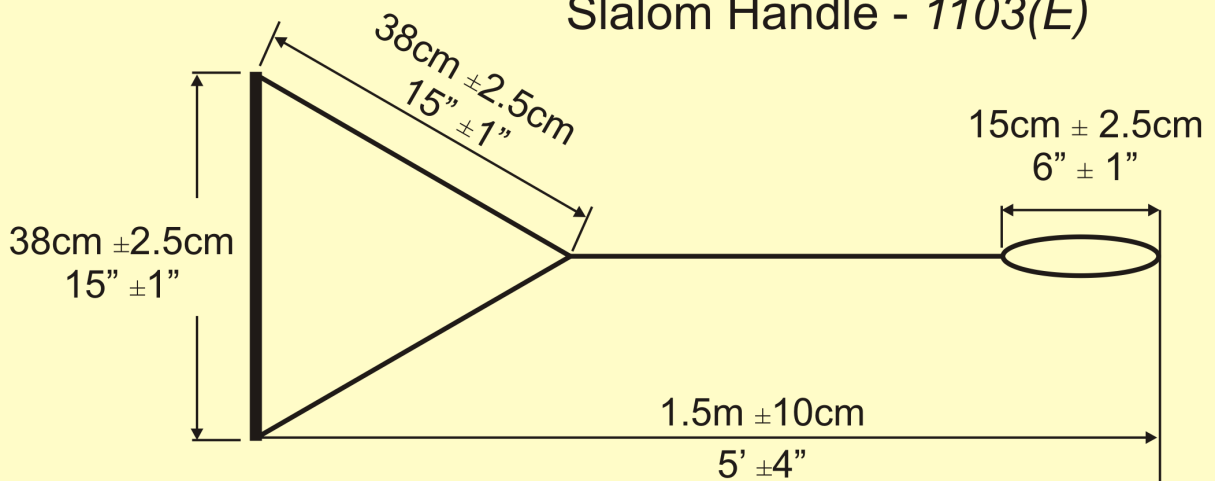

Rope and Handle - 1103(G)

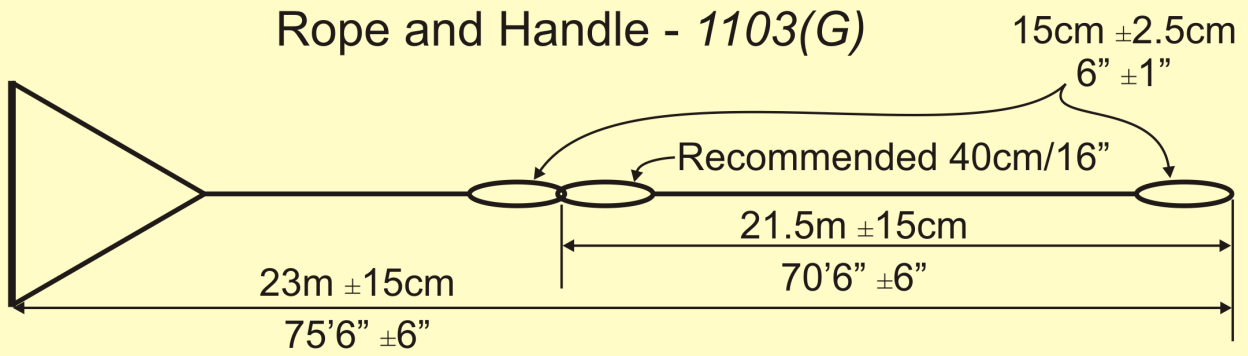

Jump Front View - 1401

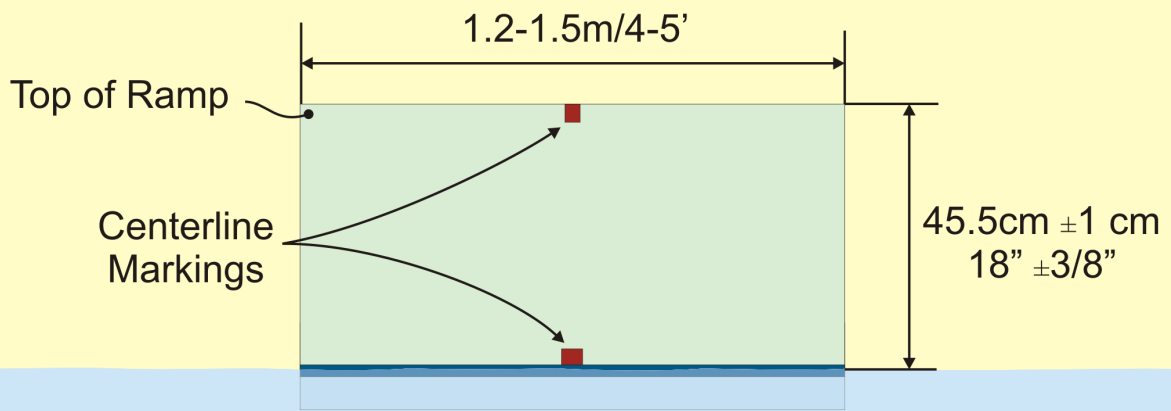

Jump Top View - 1401

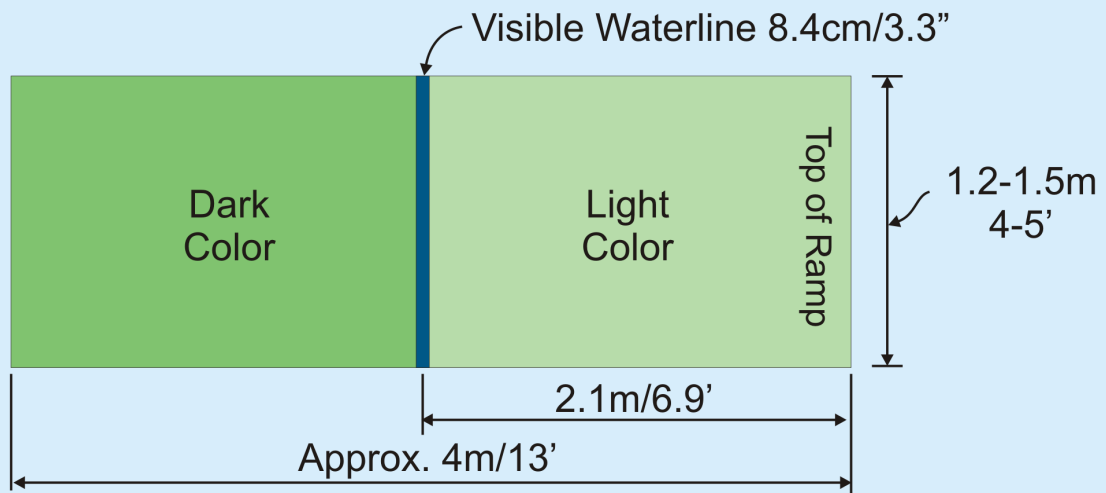

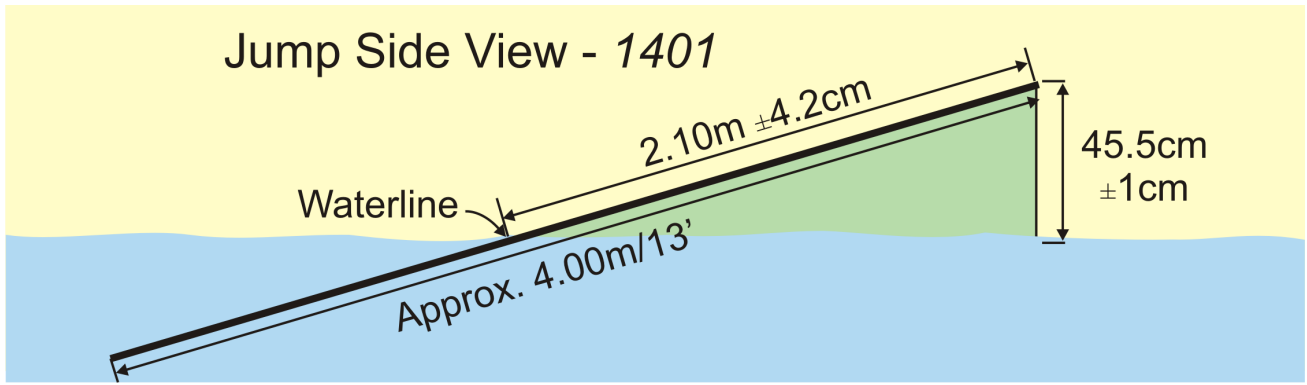

1502(B) Second Forward Slalom Pass Value after 25% Multiplier Applied							
Score	Applied	Score	Applied	Score	Applied	Score	Applied
0.1	0.03	2.1	0.53	4.1	1.03	6.1	1.53
0.2	0.05	2.2	0.55	4.2	1.05	6.2	1.55
0.3	0.08	2.3	0.58	4.3	1.08	6.3	1.58
0.4	0.10	2.4	0.60	4.4	1.10	6.4	1.60
0.5	0.13	2.5	0.63	4.5	1.13	6.5	1.63
0.6	0.15	2.6	0.65	4.6	1.15	6.6	1.65
0.7	0.18	2.7	0.68	4.7	1.18	6.7	1.68
0.8	0.20	2.8	0.70	4.8	1.20	6.8	1.70
0.9	0.23	2.9	0.73	4.9	1.23	6.9	1.73
1.0	0.25	3.0	0.75	5.0	1.25	7.0	1.75
1.1	0.28	3.1	0.78	5.1	1.28	7.1	1.78
1.2	0.30	3.2	0.80	5.2	1.30	7.2	1.80
1.3	0.33	3.3	0.83	5.3	1.33	7.3	1.83
1.4	0.35	3.4	0.85	5.4	1.35	7.4	1.85
1.5	0.38	3.5	0.88	5.5	1.38	7.5	1.88
1.6	0.40	3.6	0.90	5.6	1.40	7.6	1.90
1.7	0.43	3.7	0.93	5.7	1.43	7.7	1.93
1.8	0.45	3.8	0.95	5.8	1.45	7.8	1.95
1.9	0.48	3.9	0.98	5.9	1.48	7.9	1.98
2.0	0.50	4.0	1.00	6.0	1.50	8.0	2.00

Slalom Shorthand - 1507(C)

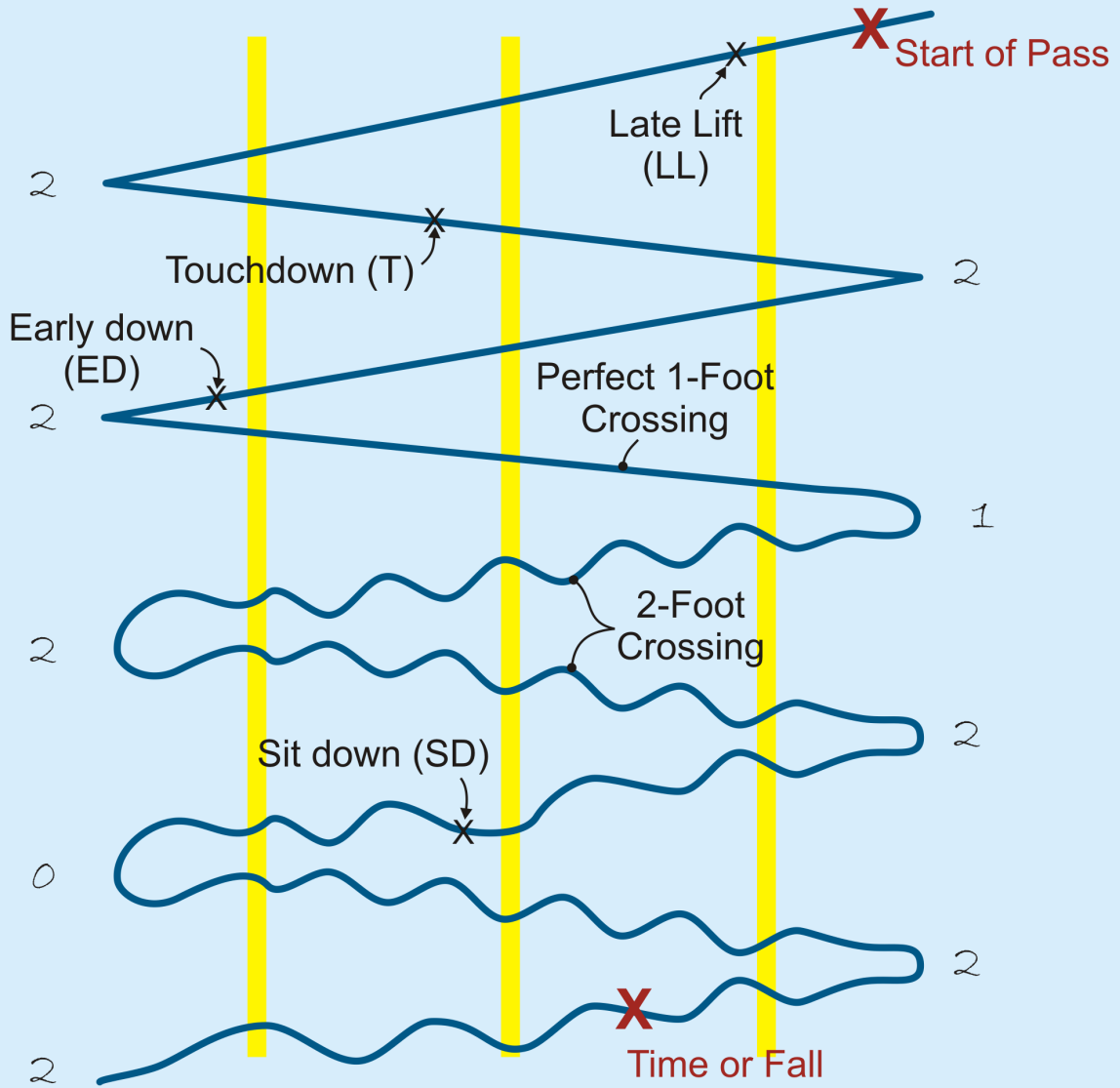

Two-Foot Crossing Score - 1509(D)(1)

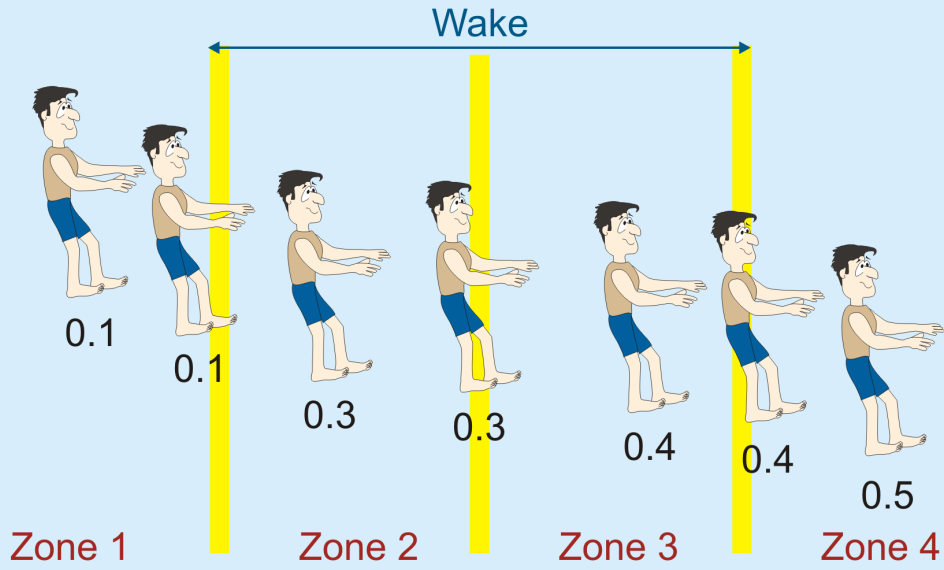

One-Foot Crossing Score - 1509(D)(2)

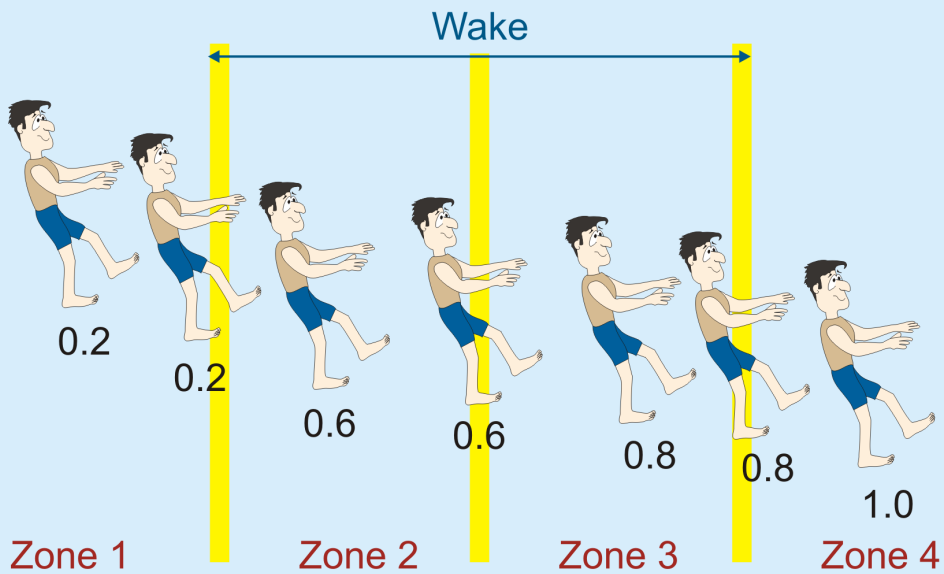

Short-Hand Tricks Symbols -1607(C)									
	Surface Tricks				Wake Tricks				Wake-to Wake
	Two Foot		One Foot		Two Foot		One Foot		
	Basic	Rev	Basic	Rev	Basic	Rev	Basic	Rev	
General									
Hop	Λ		Λ>	<Λ	Λ _v				Λ _w
Knee Skiing	K								
One Foot			>	<					
Rope in Teeth	T		T>	<T					
Rope on Neck	N		N>	<N					
Side Slide-Backward	BSS								
Side Slide-Forward	SS								
Side Slide Switch	SSS								
Sit Down Stand Up	SD		SD>	<SD					
Somersault (Flip)	O				O _v				O _w
Toe Hold			C.	.C					
Tumble 180	↘	↙	↘>	<↙					
Tumble 360	↻	↺	↻>	<↺					
Wave-One Hand	W.	.W							
Turns									
180° Turn	1.	.1	1>	<1	1 _v	v1	1> _v	v<1	1 _w
360° Turn	3.	.3	3>	<3	3 _v	v3	3> _v	v<3	3 _w
540° Turn	5.	.5	5>	<5					
720° Turn	7.	.7	7>	<7					
Step Turn 180°	S1	1S			S _v	vS			S _w
Step Turn 360°	S3	3S							
Step Turn 540°	S5	5S							
Step Turn 720°	S7	7S							
Toe Turn			C1	1C			C _v	vC	

	Trick Point Values - 1623				
	Surface Tricks		Wake Tricks		Wake-to Wake
	Two Foot	One Foot	Two Foot	One Foot	
General					
Hop-Back	100*		150§		250§
Hop-Front	20*		30§		100§
Knee Skiing	30				
One Foot-Back		100*			
One Foot-Forward		30			
Rope in Teeth	20	50	Rope in Teeth/Neck Eliminated in 2013		
Rope on Neck	20	50			
Side Slide - Backward	300§				
Side Slide - Forward	150§				
Side Slide - Switch	400§				
Sit Down Stand Up	20	40			
Somersault (Flip)	500/250§				
Toe Hold-Backward		150/50	650		900
Toe Hold-Forward		100/25		*Bonus Trick - 1609(A) Front Hop 1-foot 50 Back Hop 1-foot 100 Line Back Hop 100 Line Back 1-foot 100 § One only i.e. no reverse.	
Tumble 180	50/25	100/50			
Tumble 360	50/25	100/50			
Wave-One Hand	10				
Turns - Surface					
180 Back to Front	200/100	350/250	300/200	500/400	500
180 Front to Back	250/150	350/250	400/300	500/400	600
360 Back to Back	550/450	1050/950	700/600	1200/1100	900
360 Front to Front	450/350	950/850	600/500	1100/1000	800
540 Back to Front	750/650	1350/1250			
540 Front to Back	850/750	1450/1350			
720 Back to Back	1050/950	1850/1750			
720 Front to Front	950/850	1750/1650			
Turns - Step					
Step 180 Back to Front	350/250		500/400		850
Step 180 Front to Back	450/350		600/500		
Step 360 Back to Back	950/850				
Step 360 Front to Front	850/750				
Step 540 Back to Front	1250/1150				
Step 540 Front to Back	1350/1250				
Step 720 Back to Back	1850/1750				
Step 720 Front to Front	1750/1650				
Turns - Toe					
Toe 180 Back to Front		850/300		1500/550	
Toe 180 Front to Back		350/250		700/600	

Start Points - 1603(B)				
	Two Feet	One Foot	Flyer Bonus	Tower Bonus
Front Deep	50	100	50	150
Front Toe-Up		400		
Front Tumble	100	150	50	100
Back Deep	200	500	100	200
Back Toe-Up		450/350*		
Back Tumble	400	700	100	200

*Imperfect Version [1603(A)(11)]

STARTS - 1603(B)							
Forward Starts	Two-Foot		One-Foot	Back Starts	Two-Foot		One-Foot
Deep	50		150	Deep	200		500
Deep w/Flyer	100		150	Deep w/Flyer	300		600
Deep w/Tower	200		250	Deep w/Tower	400		700
Toe Up	400			Toe Up	450/350**		**1603(A)(11)
Tumble	100		150	Tumble	400		700
Tumble w/Flyer	150		200	Tumble w/Flyer	500		800
Tumble w/Tower	200		250	Tumble w/Tower	600		900

Trick Symbols and Points 1607(C) and 1623								
Trick	Two-Foot				One-Foot			
	Basic		Reverse		Basic		Reverse	
Hop-Back	Λ	100			Λ>	200*	<Λ	200*
Hop-Back Line	Λ ⁺	200			Λ> ⁺	300*	<Λ ⁺	300*
Hop-Front	Λ	20			Λ> ⁺	70*	<Λ ⁺	70*
Knee	K	30						
One-Ft Back					>	100*	<	100*
One-Ft Back Line					> ⁺	200*	< ⁺	200*
One-Ft Front					>	30	<	30
Teeth	T	20			T>	50	<T	50
Neck	N	20			N>	50	<N	50
Slide - Back	BSS	300						
Slide - Front	SS	150						
Slide - Switch	SSS	400						
Sit Down	SD	20			SD>	40	<SD	40
Flip	O	500/200				650		900
Toehold - Backward					C.	150/50	.C	150/50
Toehold - Forward					C.	100/25	.C	100/25
Tumble 180	↘	50/25	↙	50/25	↘>	100/50	<↙	100/50
Tumble 360	↻	50/25	↺	50/25	↻>	100/50	<↺	100/50
Wave	W.	10	.W	10				

***Bonus Trick - 1609(A)**
 Front Hop 1-foot - 50
 Back Hop 1-foot - 100
 Line Back Hop 100
 Line Back 1-foot 100

Turns - Surface								
180 Back-Front	1.	200/100	.1	200/100	1>	350/250	<1	350/250
180 Front-Back	1.	250/150	.1	250/150	1>	350/250	<1	350/250
360 Back-Back	3.	550/450	.3	550/450	3>	1050/950	<3	1050/950
360 Front-Front	3.	450/350	.3	450/350	3>	950/850	<3	950/850
540 Back-Front	5.	750/650	.5	750/650	5>	1350/1250	<5	1350/1250
540 Front-Back	5.	850/750	.5	850/750	5>	1450/1350	<5	1450/1350
720 Back-Back	7.	1050/950	.7	1050/950	7>	1850/1750	<7	1850/1750
720 Front-Front	7.	950/850	.7	950/850	7>	1750/1650	<7	1750/1650

Turns - Step					Start Points - 1603(B)				
180 Step/Back-Front	S1	350/250	1S	350/250					
180 Step/Front-Back	S1	450/250	1S	450/250					
360 Step/Back-Back	S3	950/850	3S	950/850					
360 Step/Front-Front	S3	850/750	3S	850/750					
540 Step/Back-Front	S5	1250/1150	5S	1250/1150					
540 Step/Front-Back	S5	1350/1250	5S	1350/1250					
720 Step/Back-Back	S7	1850/1750	7S	1850/1750					
720 Step/Front-Front	S7	1750/1650	7S	1750/1650					
					Front Deep	Two Feet	One Foot	Flyer Bonus	Tower Bonus
					Front Toe-Up	50	100	50	150
					Front Tumble	100	150	50	100
					Back Deep	200	500	100	200
					Back Toe-Up		450/350*		
					Back Tumble	400	700	100	200

Turns - Toe							
Toehold Back-to-Front				C1	850/350	1C	850/350
Toehold Front-to-Back				C1	350/250	1C	350/250

Where scores are separated by a slash(/), the first is for a perfect trick, the second is for an imperfect trick, which carries a penalty for not meeting all of the requirements of the trick as per 1610.